

# **WINCO**<sup>®</sup>

## **35-75 PTO GENERATORS**



# **INSTALLATION AND OPERATORS MANUAL**

WINCO INC. 225 S. CORDOVA AVE. LE CENTER, MN 56057 507-357-6821  
SERVICE DEPT. 507-357-6831  
[www.wincogen.com](http://www.wincogen.com)

# TABLE OF CONTENTS

## SAVE THESE INSTRUCTIONS

## SPECIFICATIONS

## SAFETY INFORMATION

ANSI SAFETY DEFINITIONS

## TESTING POLICY

## PREPARING THE UNIT

UNPACKING

## INSTALLATION

FOUNDATION MOUNTING

TRAILER MOUNTING

## ELECTRICAL CONNECTIONS

## OPERATION

## PRE-START CHECKS

## GENERATOR PROCEDURES

STARTUP

## MAINTENANCE

GENERAL

LUBRICATION

CLEANING & INSPECTING THE GENERATOR

SHUTDOWN

GENERATOR STORAGE

## TROUBLE SHOOTING TABLES

## WIRING DIAGRAMS

## 36 MONTH LIMITED WARRANTY

COPY YOUR MODEL AND SERIAL NUMBER HERE

No other WINCO generator has the same serial number as yours.

If you should ever need to contact us on this unit, it will help us to respond to your needs faster.

MODEL \_\_\_\_\_

SERIAL NUMBER \_\_\_\_\_

PURCHASE DATE \_\_\_\_\_

DEALER NAME \_\_\_\_\_

DEALER PHONE # \_\_\_\_\_

# SAVE THESE INSTRUCTIONS

- 2** This manual contains important instructions that should be followed during installation and maintenance of the generator. Read and understand all instructions in the manual before starting and operating the generator.

## USING THIS MANUAL

- 4** Congratulations on your choice of a WINCO generator. You have selected a high-quality, precision-engineered generator designed and tested to give you years of satisfactory service.

- 4** To get the best performance from your new generator, it is important that you carefully read and follow the operating instructions in this manual.

- 5** Should you experience a problem please follow the "Troubleshooting Tables" near the end of this manual. The warranty listed in the manual describes what you can expect from WINCO should you need service assistance in the future.

**7**

**8**

## SPECIFICATIONS

### 35PTOC-3

Watts	35,000
Phase	Single
Voltage	120/240
Power Factor	1.0
Amps	146
Input Speed	540 RPM
Generator Speed	1800 RPM
Input Shaft	1 3/8" - 6 spline
Required Tractor PTO HP	70

**9**

**10**

**12**

### 40PTOC-4

Watts	40,000
Phase	Three
Voltage	120/208
Power Factor	0.8
Amps	139
Input Speed	540 RPM
Generator Speed	1800 RPM
Input Shaft	1 3/8" - 6 spline
Required Tractor PTO HP	80

### 45PTOC-17

Watts	45,000
Phase	Three
Voltage	120/240
Power Factor	0.8
Amps	135
Input Speed	540 RPM
Generator Speed	1800 RPM
Input Shaft	1 3/8" - 6 spline
Required Tractor PTO HP	90

### 50PTOC-3

Watts	50,000
Phase	Single
Voltage	120/240
Power Factor	1.0
Amps	208
Input Speed	540 RPM
Generator Speed	1800 RPM
Input Shaft	1 3/8" - 6 spline
Required Tractor PTO HP	100

### 75FPTOC-4

Watts	75,000
Phase	Three
Voltage	120/208
Power Factor	0.8
Amps	260
Input Speed	1000 RPM
Generator Speed	1800 RPM
Input Shaft	1 3/8" - 6 spline
Required Tractor PTO HP	150

### 75FPTOC-4

Watts	75,000
Phase	Three
Voltage	120/240
Power Factor	0.8
Amps	225
Input Speed	1000 RPM
Generator Speed	1800 RPM
Input Shaft	1 3/8" - 6 spline
Required Tractor PTO HP	150

## SAFETY INFORMATION

This engine generator set has been designed and manufactured to allow safe, reliable performance. Poor maintenance, improper or careless use can result in potentially deadly hazards; from electrical shock, exhaust gas asphyxiation, or fire. Please read all safety instructions carefully before installation or use. Keep these instructions handy for future reference. Take special note and follow all warnings on the unit labels and in the manuals.

## ANSI SAFETY DEFINITIONS

### DANGER:

*DANGER indicates an imminently hazardous situation which, if not avoided, will result in death or serious injury. This signal word is to be limited to the most extreme situations.*

### WARNING:

*WARNING indicates a potentially hazardous situation which, if not avoided, could result in death or serious injury.*

### CAUTION:

*CAUTION indicates a potentially hazardous situation which, if not avoided, may result in minor or moderate injury. It may also be used to alert against unsafe practices.*

### 1. ELECTRICAL SHOCK -

The output voltage present in this equipment can cause fatal electric shock. This equipment must be operated by a responsible person.

- Do not allow anyone to operate the generator without proper instruction.
- Guard against electric shock.
- Avoid contact with live terminals or receptacles.
- Use extreme care if operating this unit in rain or snow.
- Use only three-pronged grounded receptacles and extension cords.
- Be sure the unit is properly grounded to an external ground rod driven into the earth.

### 2. FIRE HAZARD -

Gasoline and other fuels present a hazard of possible explosion and/or fire.

- Do not refuel when the engine is running or hot.
- Keep fuel containers out of reach of children.
- Do not smoke or use open flame near the generator set or fuel tank.
- Keep a fire extinguisher nearby and know its proper use. Fire extinguishers rated ABC by NFPA are appropriate.
- Store fuel only in an approved container, and only in a well ventilated area.
- Follow local codes for closeness to combustible material.

### 3. DEADLY EXHAUST GAS -

Exhaust fumes from any gasoline engine contain carbon monoxide, an invisible, odorless and deadly gas that must be mixed with fresh air.

- Operate only in well ventilated areas.
- Never operate indoors including attached garages
- Never operate the unit in such a way as to allow exhaust gases to seep back into closed rooms (i.e. through windows, walls, floors).

### 4. NOISE HAZARD -

Excessive noise is not only tiring, but continual exposure can lead to loss of hearing.

- Use hearing protection when working around this equipment for long periods of time.
- Keep your neighbors in mind when using this equipment.

### 5. CLEANLINESS -

Keep the generator and surrounding area clean.

- Remove all grease, ice, snow or materials that create slippery conditions around the unit.
- Remove any rags or other materials that could create a potential fire hazard.
- Carefully clean up any gas or oil spills before starting the unit.

## 6. SERVICING EQUIPMENT -

All service, including the installation or replacement of service parts, should be performed only by a qualified technician.

- A. Use only factory approved repair parts.
- B. Do not work on this equipment when fatigued.
- C. Never remove the protective guards, covers, or receptacle panels while the engine is running.
- D. Use extreme caution when working on electrical components. High output voltage from this equipment can cause serious injury or death.
- E. Always avoid hot mufflers, exhaust manifolds, and engine parts. They can cause severe burns instantly.
- F. The use of the engine-generator set must comply with all national, state, and local codes.

## TESTING POLICY

Before any generator is shipped from the factory, it is fully checked for performance. The generator is loaded to its full capacity, and the voltage, current, and frequency are carefully checked.

Rated output of generator is based on engineering tests of typical units, and is subject to, and limited by, the temperature, altitude, fuel, and other conditions specified by the manufacturer of applicable engines.

## PREPARING THE UNIT

### UNPACKING

#### CAUTION: EQUIPMENT DAMAGE

When you unpack your new generator, be sure to remove all of the information sheets and manual from the carton.

1. As you receive your unit, it is critical to check it for any damage. If any damage is noted, it is always easiest to refuse the shipment and let WINCO take care of the freight claim. If you sign for the unit, the transfer of the ownership requires that you file the freight claim
2. Before proceeding with the preparations of your new generator for operation, take a couple of minutes to ensure the unit you have received is the correct model and review the specification pages in this manual to ensure that this unit meets your job requirements.

## INSTALLATION

Note: PTO mounting holes are .75".

### FOUNDATION MOUNTING

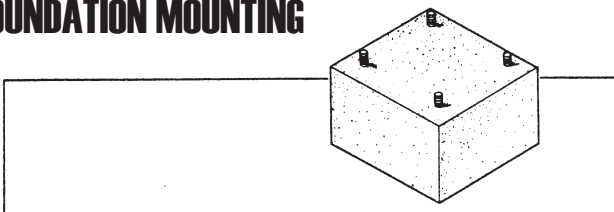

Mount the generator on a foundation if it is to be used as a permanent or standby power source. When planning a foundation, consider the following points:

- A. The foundation location should enable aligning the drive shaft (tumbling bar) in a straight or nearly-straight line between the power take-off and the generator input shaft. Misalignment must be less than 15 degrees during generator operation, even though the mechanical design of the tumbling bar may allow greater misalignment.
- B. The foundation must be solid enough to absorb generator starting and reflected load torque during operation.
- C. The foundation surface should be flat.
- D. Space is required around the generator for mounting switching devices, making connections, and for servicing.
- E. For dimensions needed for your specific generator, please refer to its outline drawing. The hardware needed is dependent on your distinct application.

F. All four generator mounting pads must rest firmly on the foundation. Install shims if necessary to even out the foundation under the mounting pads, then bolt the generator firmly in place.

### TRAILER MOUNTING

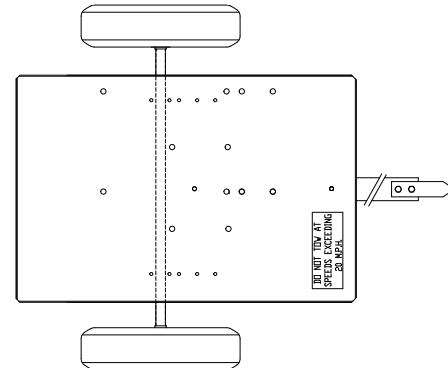

Mount the generator on a trailer if you plan to use it as a portable power source. When selecting or building a trailer to mount the generator, consider the following points:

- A. The trailer construction must be strong enough to support the generator.
- B. The design of the trailer must enable the trailer to remain stable during operation, and to resist tipping caused by generator starting and reflected load torque.

#### WARNING: PERSONAL INJURY & EQUIPMENT DAMAGE

Trailer may tip over and cause injuries if wheels are not spaced far enough apart.

C. The trailer height and mounting position of the generator on the trailer should enable aligning the drive shaft (tumbling bar) in a straight or nearly straight line between the power take-off and generator input shafts. Misalignment must be less than 15 degrees during generator

operation, even though the mechanical design of the tumbling bar would allow greater misalignment.

D. The generator mounting area of the trailer bed should be flat. All four generator mounting pads must rest firmly on the trailer bed. Install shims if necessary to even out the bed under the mounting pads, then bolt the generator firmly in place.

## ELECTRICAL CONNECTIONS

### CAUTION:

Only qualified electricians should install electric wiring. Wiring must conform to all applicable national, state, and local codes. (Reference: National Fire Protection Association Manual No. 70, National Electrical Code.)

### DANGER: PERSONAL INJURY

If the generator is to be used as a standby power source, a special disconnect switch must be installed to separate the generator and the commercial power lines. The disconnect must isolate the generator from the commercial power lines and the load when the generator is on standby, and must isolate the commercial power lines from the load and generator when the generator is supplying power.

A properly rated and installed double throw manual power isolation transfer switch must be used with a standby generator. The transfer switch isolates the load from the power line and allows you to safely operate your loads without endangering the power line repair crew. See previous diagrams

The load, connected to the normal terminals of the transfer switch, is energized by the normal power line when the switch is in the normal position. The generator, connected to the emergency terminals of the switch, furnishes power when the switch is in the emergency mode position.

There are two ways to install a manual transfer switch. The first is to install the switch between the watt-hour meter and the normal distribution panel. As with any system you must install an entrance rated breaker before the manual transfer switch. The manual transfer switch must in all cases be equal to or greater than the rating of the entrance rated breaker.

The second way to install the system is to purchase and install an emergency distribution panel and move the circuits you wish to back up to the new distribution panel. In this case the manual transfer switch only has to be sized to the amperage of the circuit breaker in the main distribution panel that is feeding it.

Before deciding which system to install, first determine which loads you can safely run on your PTO generator and the cost of buying a large manual transfer switch versus the cost of a smaller switch and the additional distribution panel.

The only assembly work required after unpacking the generator is to assemble the load disconnect plug, which is contained in a bag in the sub-pack carton packed in the generator crate.

The bag contains an instruction sheet, 2 plug bodies, four contacts, a handle and the hardware to assembly the disconnect plug. You will need to purchase the appropriate length of fine stranded copper wire for your application in order to complete the assembly of the disconnect plug.

The following wire sizes are recommended for each unit.

Model	AWG	Insulation
35PTOC-3	#2	Neoprene/THHN
40PTOC-4	#4	Neoprene/THHN
45PTOC-17	#4	Neoprene/THHN
50PTOC-3	#1	Neoprene/THHN
75FPTOC-4	#1	Neoprene/THHN
75FPTOC-17	#1	Neoprene/THHN

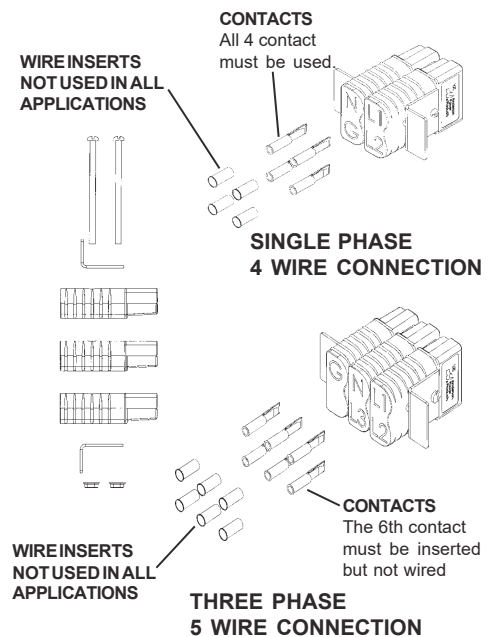

### WARNING: EQUIPMENT DAMAGE

Never use acid core solder. When soldering insure no excess solder runs down on the contact surface - Solder on the contact surface will not allow the contacts to mate properly causing them to burn up.

Each wire should be stripped back 7/8 of an inch and inserted into one of the contacts in the plug kit. You will then either need to solder them together using a good grade of resin core solder or they can be crimped with an appropriate compression crimper or both.

Approved crimping tools are:

1. Anderson Power Products
2. ETC Model HHS hydraulic crimper
3. ITT Blackburn No. 1640
4. Thomas & Betts #TBM5

To complete the assembly of the disconnect plug refer to the instruction sheet in the plug kit.

### WARNING: ELECTRICAL SHOCK

During the next step, the load disconnect plug should not be plugged into its receptacle. Also, make sure that the equipment to which the



plug leads (cables) are being connected is not energized (live).

Strip the insulation off of the free end of each of the plug leads (cables) and connect them to the load transfer switch or directly to the load.

**IMPORTANT: When making standby service hook up, make sure load to be transferred to standby generator will not exceed generator rating.**

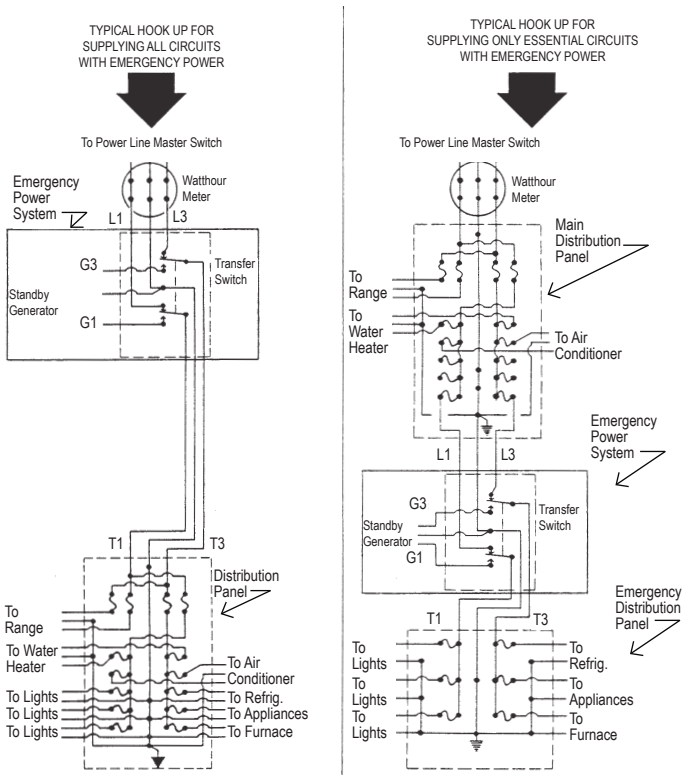

## OPERATION

Output power available and load determination

Before using the generator, read and understand the following information.

Generator output current (amperage) is internally limited by three circuit breakers. If too much demand is placed on a generator output (if you try to drive too many motors with it, for example), one of the circuit breakers will trip, cutting off the output in order to protect the generator.

A 20 Amp push-to-reset circuit breaker protects the 120V duplex receptacle output circuit. 20 Amps is the total limit for both outputs of the duplex receptacle.

A 50 Amp push-to-reset circuit breaker protects the 240V receptacle output circuit.

A large two pole (three pole for three phase) switch type main circuit breaker protects the generator windings and output circuits, including the load disconnect receptacle. On the W145PTOT and the W150PTOS, you will connect your power output leads directly to the mainline circuit breaker.

To aid in determining how much load can be applied to the generator, and how it should be distributed among the generator output receptacles, the following formulas may be useful. Get load voltages, current, and wattage from the nameplates on the equipment in the load.

$$\text{Load current (in Amps)} \times \text{Load voltage} = \text{Load wattage}$$

$$\text{Amps} \times \text{Volts} = \text{Watts}$$

$$\text{Watt}/1000 = \text{kW}$$

$$\text{Load wattage} / \text{Load voltage} = \text{Load current (in Amps)}$$

Example: 250W, 120V floodlight load:  $250\text{W} / 120\text{V} = 2$  Amps (parrots.)

**NOTE:** Electric motors require more current to start than to run. Commonly, the current rating given on a motor nameplate is the full load (running) current required by the motor, not its starting current, which is a lot higher. Motor starting current requirements vary greatly, by motor size and type. Repulsion-induction type motors are the easiest to start, typically using 1 1/2 to 2 1/2 times as much current to start as to run; capacitor type motors usually require 2 to 4 times as much current to start as to run; split-phase type motors are the hardest to start, normally using 5 to 7 times as much current to start as to run.

Motor Load Motor HP	Single Phase		Three Phase	
	115 V Amps	230V Amps	208V Amps	240V Amps
1/4	5.8	2.9	-	-
1/3	7.2	3.6	-	-
1/2	9.8	4.9	2.3	2.0
3/4	13.8	6.9	3.2	2.8
1	16	8	4.15	3.6
1 1/2	20	10	6.0	5.2
2	24	12	7.8	6.8
3	34	17	11	9.6
5	56	28	17.5	15.2
7 1/2	80	40	25	22
10	100	50	32	28
20	-	-	62	54
40	-	-	120	104

The previous table was compiled from the NEC Manual. Amps shown are running amps.

To use the full capacity of the generator without tripping circuit breaker(s), start the motor first, next highest second, etc. Use the preceding table as a source of general information about motor running current requirements. For more specific information, see motor nameplate or motor manufacturer's catalog.

## PRE-START CHECKS

### WARNING: PERSONAL INJURY:

When working on or around these generators, do NOT wear loose fitting clothing or any articles that may get caught in moving parts.

1. Visually inspect the generator. Check for:
  - a. Correct mounting.
  - b. Physical damage.

- c. Debris in cooling vents and screens. (Could cause generator to overheat)

**IMPORTANT:**

The manufacturer recommends that, if the generator has been stored for any length of time, before using it, the operator remove the control box cover and cooling fan screen, then inspect the generator for rodent nests or other objects that could cause generator binding and/or overheating. See 'Cleaning' portion of the Maintenance section.

- 2. Check Gearcase oil level. (See drawing) Case should be filled with oil to plug marked 'OIL LEVEL'. Fill or remove oil as required.

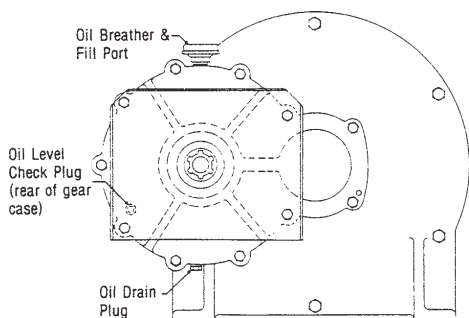

NOTE: Either too little or too much oil can harm the equipment.

See 'Lubrication' portion of Maintenance for oil specifications.

- 3. Make sure the drive shaft (tumbling bar) is assembled with its universal joint knuckles "synchronized," as illustrated below. If knuckles are not synchronized, the bar will chatter when rotating, which will cause the generator output voltage to flicker. Drive shafts shipped new from Winco are always synchronized and tethered so they can not be taken apart.

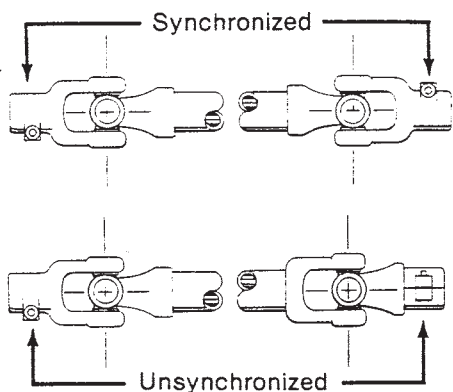

**DANGER: PERSONAL INJURY:**

Power take-off must be disengaged at this time.

- 4. Couple the tractor to the generator with the drive shaft (tumbling bar). Couple the tumbling bar to the generator input shaft first, then to the power take-off shaft. Check alignment, tractor, power take-off shaft (tumbling bar), and generator input shaft should form a straight (or nearly straight) line, with less than 5° misalignment between the shafts. Misalignment will cause generator output voltage to flicker.

**WARNING: PERSONAL INJURY:**

Make sure that all tumbling bar lock pins are engaged and that all safety shields are in place before operating the PTO generator.

- 5. Make sure no binding exists in generator or gear box. If binding is found, locate the cause and correct it before proceeding.
- 6. Make sure that the electrical loads to be driven by the generator will not draw more current than the ratings of the generator receptacle or cord set which will supply the current.
- 7. Check all electrical connections in the system to be energized by the generator. Make sure the connections are correct and are tight.
- 8. Make sure all loads are turned off. Do not start the generator under load.

## GENERATOR PROCEDURES

### STARTUP

- 1. Set the manual transfer to mid or normal (up) position.
- 2. With the power take-off drive disengaged, start the engine which will drive the generator. Run the engine long enough to warm it up before proceeding, so that it will run smoothly and achieve full power under generator load.
- 3. With the engine idling, engage the power take-off drive.
- 4. Watch the voltmeter on the generator and slowly increase engine speed until the output reaches approximately 240 to 245 Volts (208 to 212 for 208 Volt generator), in green portion of voltmeter scale.
- 5. Plug load cord set into receptacle. Place transfer switch in the emergency position.
- 6. Place the load circuit breaker in the "on" position. If the breaker trips, move manual transfer switch to "off" or normal position. Check for short circuit or grounded connection in the load cable to the double throw switch and repair. A breaker that trips from overload or short circuit must be reset by moving to "off" before re-closing.
- 7. With engine and generator running smoothly, switch on the electrical load while watching the voltmeter. Readjust engine throttle to keep generator output under load at 240V (208V if applicable) in green portion of voltmeter scale. If engine is equipped with speed governor, it may automatically readjust the throttle as the load changes and keep the generator output at the proper level. However, some governors are not sensitive enough to maintain proper output under changing load, and in such cases the throttle will have to be manually readjusted.

**NOTE: EQUIPMENT DAMAGE**

If the load includes motors, turn them on one at a time, highest starting current motor first, next highest second, etc.

Adjust engine throttle to keep generator output under load at 60Hz. If the engine is equipped with a governor, it may automatically adjust the throttle as the load changes and keep the generator output at the proper level. However, some governors are not sensitive enough to maintain proper output under changing loads, and in such cases, the

frequency will have to be monitored closely and manually adjusted.

## SHUTDOWN

1. Switch off electrical load.
2. Reduce Speed of engine driving generator to idle.
3. Disengage power take-off drive, and allow generator to coast to a stop.

### WARNING: PERSONAL INJURY

*Never try to stop the generator. Always let it coast until it stops.*

4. Shut off the engine.
5. Disconnect the drive shaft (tumbling bar) power take-off end first, then the generator end.

## MAINTENANCE

### CAUTION: EQUIPMENT DAMAGE

*Most electrical equipment in North America operates satisfactorily at frequencies between 59 and 61 Hz (cycles per second). Operating the generator at frequencies outside that range may cause damage to the generator and/or to electrical equipment driven by the generator.*

## GENERAL

Routine preventative maintenance minimizes costly repairs and generator downtime. Before each use, inspect the generator: gear case oil level should be correct, cooling vents and screens should be clear, and generator mounting hardware should be tight. Clean and inspect the generator after storing it for long periods, and after using it in extremely dusty conditions or in severe weather, such as rain or blowing snow.

## LUBRICATION

The generator bearings are factory lubricated and sealed, and require no further lubrication.

The splined generator input shaft should be cleaned and lubricated with thin film of grease before and after each use of the generator.

The drive shaft (tumbling bar) requires greasing. Keep the universal joints in the coupling shaft free from grease and dirt buildup.

### NOTE:

*Do not over lubricate the universal joints.*

See following illustration for recommended lubrication schedule for the coupling shaft.

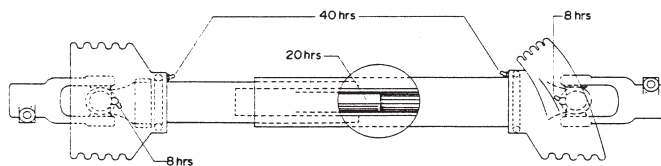

Check the generator gear case oil level before each use of the generator. Maintain the oil level at oil level plug height. The generator is shipped with lubricant in the gearcase. Specifications for the gearcase lubricant are:

API Service: GL-5  
Grade: SAE 85W-90-140  
Amount: 1 Pint

### CAUTION: EQUIPMENT DAMAGE

*Do not overfill generator gearcase. Overfilling causes overheating and oil seal failure.*

Change the oil at least once every six months. Change it more often if you use the generator in bad weather. Use the following procedure to change the generator gearcase oil.

1. Remove gearcase breather. Soak breather in cleaning solvent, then allow to dry.

2. Remove oil level plug. See illustration.

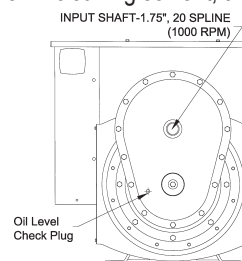

3. Remove the oil drain plug, drain the oil into a clean oil resistant container, 1 quart or larger. Check the oil for metal. Fine metal dust in the oil does not indicate trouble, but metal chips do. Dismantle the gearcase and look for damaged gears if you find metal chips in the oil.

4. Replace the oil drain plug. Refill the gearcase through the breather port with new oil of the recommended type. Fill the case up to the oil level check plug height. About 1 pint.

5. Replace the oil level check plug.

6. Replace the breather.

## CLEANING & INSPECTING THE GENERATOR

Use a vacuum cleaner or dry low pressure compressed air (regulated at 25-35PSI) to clean the generator periodically.

### WARNING: EQUIPMENT DAMAGE

*Do NOT clean the generator while it is running.*

Proceed as follows:

1. Remove ventilated control box cover. Vacuum or blow vents and screen clear of dust or debris. Wash them down with cleaning solvent if necessary.



2. Remove cooling fan shroud. Vacuum or blow dust from screen and fan blades. Wipe them off with cleaning solvent if necessary.

3. Vacuum or blow dust and other debris from inside generator and control box.

## GENERATOR STORAGE

Before storing the generator, apply a heavy coat of grease to the splined input shaft. Store the generator in a sheltered area, where it is protected against snow, rain, and excessive dust.

## TROUBLE SHOOTING TABLES

SYMPTOM	CAUSE(S)	CORRECTIVE ACTION
No output voltage	<ol style="list-style-type: none"> <li>1. Circuit breaker open</li> <li>2. Defective frequency meter</li> <li>3. short circuit in the load</li> <li>4. defective receptacles</li> <li>5. Loose (or broken) wires or connections in control box</li> <li>6. Defective rotating rectifier</li> <li>7. Defective AVR</li> <li>8. Shorted or open rotor</li> <li>9. Shorted or open stator</li> </ol>	<ol style="list-style-type: none"> <li>1. Reset circuit breakers, replace if defective</li> <li>2. Check output with another meter, replace meter if defective.</li> <li>3. Disconnect the load. Check voltage at receptacle cord set. Check motors, appliances, and load leads for short circuit. Repair short.</li> <li>4. Remove panel cover and check for voltage to the receptacles. Replace defective receptacles.</li> <li>5. Remove panel cover and check all wiring and connections. Tighten and/or repair where necessary.</li> <li>6. Test rectifier. Replace if defective.</li> <li>7. Repair or replace as required.</li> <li>8. Measure rotor resistance. Replace rotor if open or shorted.</li> <li>9. Measure between leads for open r short. Replaces stator if defective.</li> </ol>
High voltage	<ol style="list-style-type: none"> <li>1. Defective or misadjusted AVR</li> </ol>	<ol style="list-style-type: none"> <li>1. Adjust, repair, or replace as required</li> </ol>
Low voltage	<ol style="list-style-type: none"> <li>1. Engine speed too low</li> <li>2. Generator overloaded</li> <li>3. Inadequate engine horsepower.</li> <li>4. Defective or misadjusted AVR</li> </ol>	<ol style="list-style-type: none"> <li>1. Check engine speed. Increase RPM if necessary.</li> <li>2. Reduce load if it is higher than the rated capacity of the generator. (see generator nameplate)</li> <li>3. Generator requires 2 HP/1000 watt output. Obtain larger engine if necessary.</li> <li>4. Repair, adjust, or replace as required.</li> </ol>
Output voltage flickering or fluctuation	<ol style="list-style-type: none"> <li>1. Tumbling bar (shaft) misalignment</li> <li>2. Engine governor may be worn or improperly adjusted. Set or repair defective governor.</li> <li>3. Loose connection in field circuit</li> <li>4. Tumbling bar U-Joints not synchronized</li> </ol>	<ol style="list-style-type: none"> <li>1. Reduce tumbling bar misalignment to less than 15 degrees</li> <li>2. Engine governor may be worn or improperly adjusted. Set or repair defective governor.</li> <li>3. Check and tighten connections.</li> <li>4. Reassemble tumbling bar.</li> </ol>
Excessive vibration	<ol style="list-style-type: none"> <li>1. Power take-off misalignment excessive</li> <li>2. Loose mounting nuts and bolts or hold down studs</li> <li>3. Universal joints in coupling shaft worn or dry.</li> <li>4. Defective bearings</li> </ol>	<ol style="list-style-type: none"> <li>1. Correct misalignment. It should be less than 15 degrees.</li> <li>2. Tighten mounting buts and bolts; repair hold down stud mountings.</li> <li>3. Repair or replace defective parts.</li> <li>4. Check for possible causes. Replace defective bearings.</li> </ol>
Generator overheating	<ol style="list-style-type: none"> <li>1. Poor ventilation</li> <li>2. Generator overloaded</li> <li>3. Shorted turns in field or stator windings.</li> </ol>	<ol style="list-style-type: none"> <li>1. Clean ventilation and cooling fan screens.</li> <li>2. Reduce load, then check voltage and current.</li> <li>3. Replace defective components.</li> </ol>
Oil Leak	<ol style="list-style-type: none"> <li>1. Loose plug in gearcase</li> <li>2. Defective seal, gasket, or plug in gearcase</li> </ol>	<ol style="list-style-type: none"> <li>1. Tighten plug.</li> <li>2. Replace seal(s), gaskets or plugs. Maintain correct oil level.</li> </ol>

# WIRING DIAGRAMS

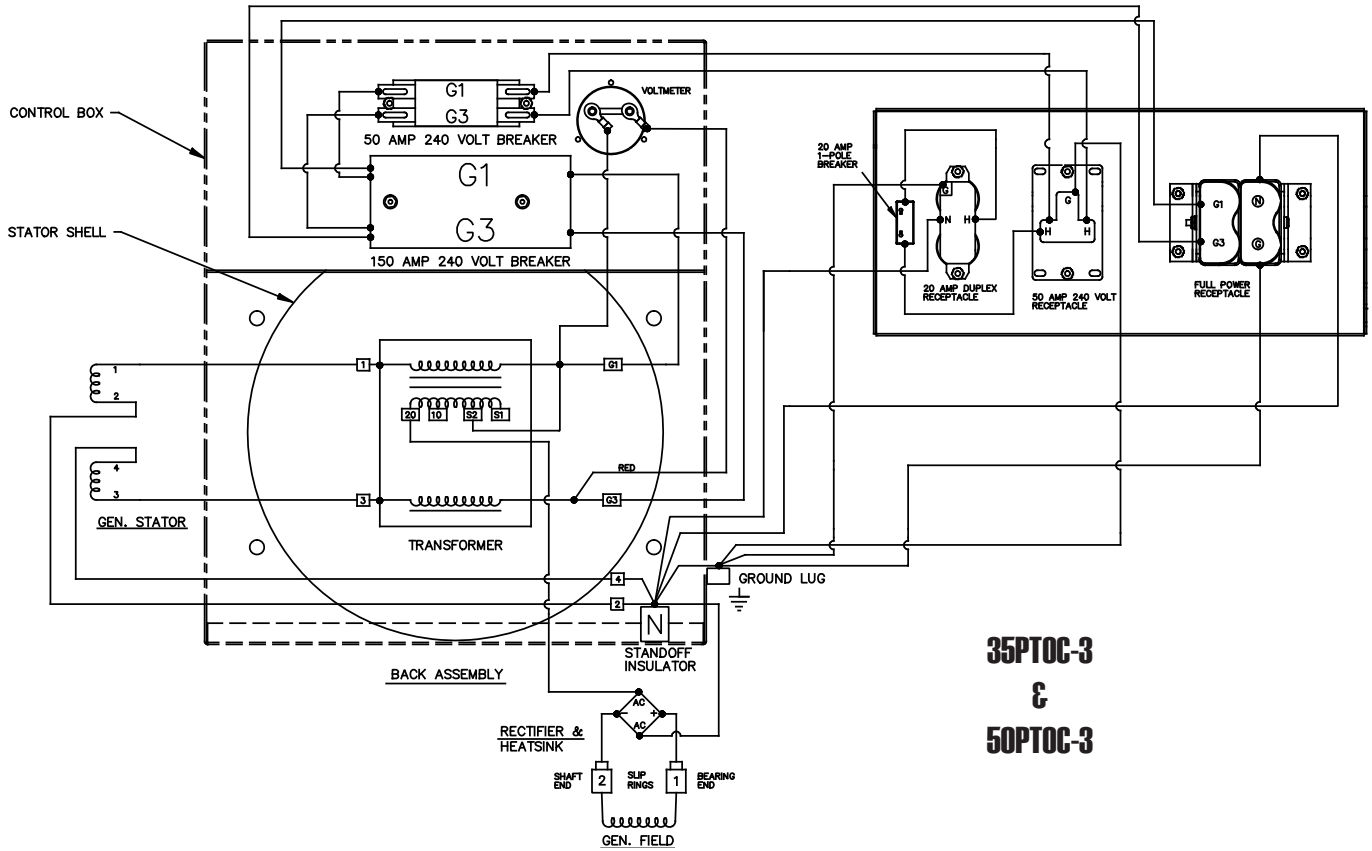

**35PTOC-3**  
**&**  
**50PTOC-3**

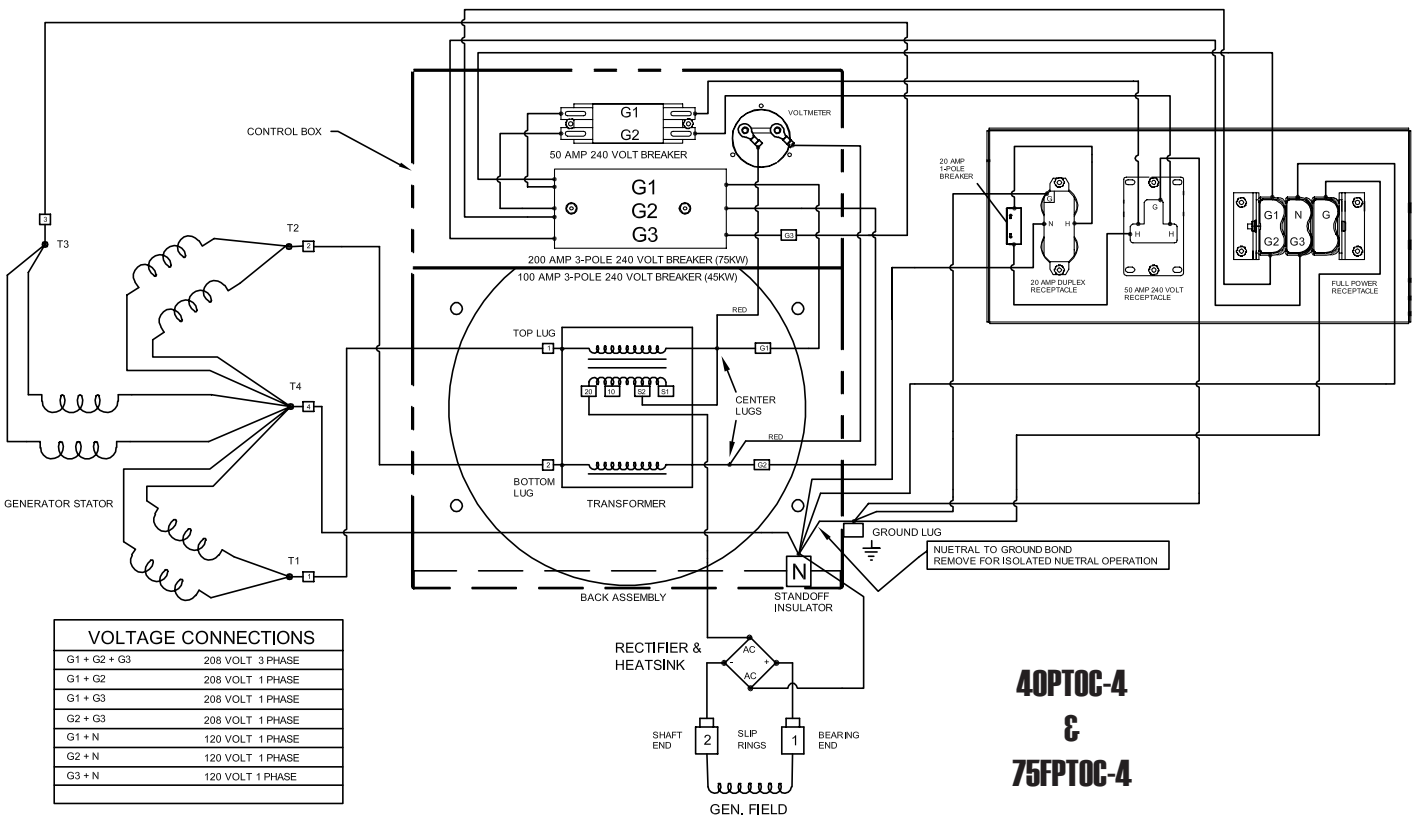

**40PTOC-4**  
**&**  
**75FPTOC-4**

VOLTAGE CONNECTIONS	
G1 + G2 + G3	208 VOLT 3 PHASE
G1 + G2	208 VOLT 1 PHASE
G1 + G3	208 VOLT 1 PHASE
G2 + G3	208 VOLT 1 PHASE
G1 + N	120 VOLT 1 PHASE
G2 + N	120 VOLT 1 PHASE
G3 + N	120 VOLT 1 PHASE

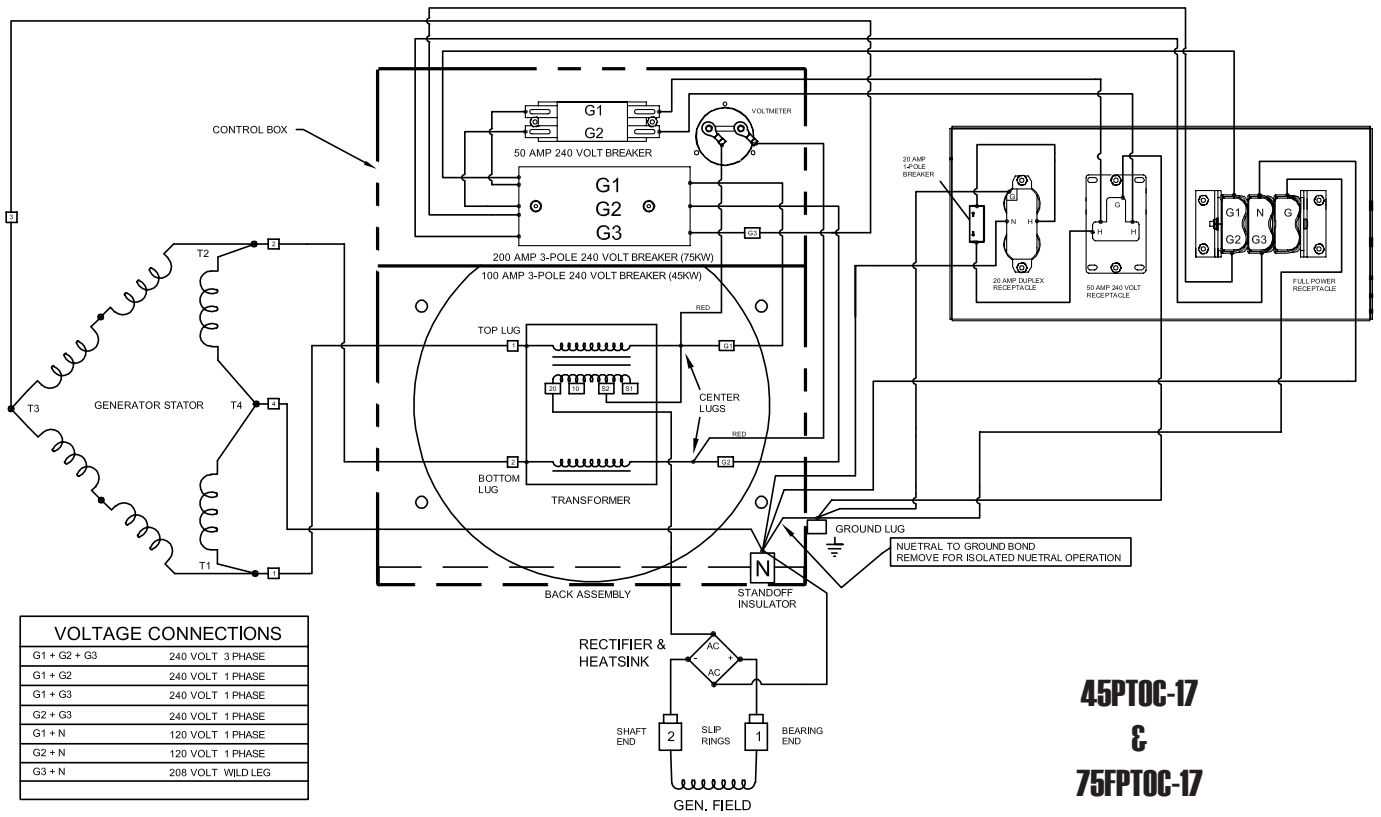

**VOLTAGE CONNECTIONS**

G1 + G2 + G3	240 VOLT 3 PHASE
G1 + G2	240 VOLT 1 PHASE
G1 + G3	240 VOLT 1 PHASE
G2 + G3	240 VOLT 1 PHASE
G1 + N	120 VOLT 1 PHASE
G2 + N	120 VOLT 1 PHASE
G3 + N	208 VOLT WILD LEG

**45PTOC-17**  
**&**  
**75FPTOC-17**



## **36 MONTH LIMITED WARRANTY**

WINCO, Inc., warrants for thirty-six months from date of shipment, that it will repair or replace at its option, for the original user, the whole or any part of the product found upon examination, by WINCO at its factory at 225 South Cordova Avenue, Le Center, Minnesota, or by any factory-authorized service station, to be defective in material or workmanship under normal standby use (average less than 50 hours per month) and service.

For warranty service, return the product within 36 months from the date of purchase, transportation charges prepaid, to your nearest factory-authorized service station or the WINCO factory. THERE IS NO OTHER EXPRESS WARRANTY.

There is no other express warranty. To the extent permitted by law, any and all warranties, including those of merchantability and fitness for a particular purpose, are limited to 36 months from date of shipment, and liability for incidental or consequential damages or expenses is excluded. Some states do not allow limitations on the duration of an implied warranty, and some states do not allow the exclusion or limitation of incidental or consequential damages, so that above limitation or exclusion may not apply to you. This warranty gives you specific legal rights; you may have other rights which vary from state to state. Note: Some states do not allow limitation on the duration of implied warranty and some states do not allow the exclusion or limitation of incidental or consequential damages, so the above limitations may not apply in every instance. This warranty gives you specific legal rights which may vary from state to state.

### **EXCLUSIONS:**

WINCO does not warrant drive lines, trailer tires, receptacles, or certain other component parts of the product installed by others, since such items are warranted by their manufacturers.

WINCO does not warrant modifications or alterations which were not made or authorized by the WINCO factory and which affect the stability or reliability of the product.

WINCO does not warrant products which have been exposed to misuse and/or negligence or have been involved in an accident.

WINCO does not warrant products which have been installed in such a manner as not to protect them from the adverse environmental conditions (water, mud, insects, etc.) or have not been kept clean.

WINCO reserves the right to change or improve its products without incurring any obligations to make such changes or improvements on products purchased previously.

This warranty is limited to bench labor and parts only, no allowance will be made for travel time, or removal and reinstallation of the PTO unit.