

USER AND MAINTENANCE MANUAL



TYPE: **MARINE GENERATORS**

MODEL: **PAGURO 3SY/4SY/5.5SY**

YEAR OF CONSTRUCTION: **2020**

VTE
VOLPI TECNO ENERGIA



VTE Srl – Via Luciano Lama, 5 – 33059 Fiumicello – Villa Vicentina (UD) – Italy
Phone: +39 0431 96488 – e-mail: info@volpitemco.com
Website: www.volpitemco.com

REVISIONS TABLE

CHAPTER	DESCRIPTION	REVISION	DATE
WA	Warnings	0.0	12.03.2020
1	Technical specifications	0.0	12.03.2020
2	Operating conditions	0.0	12.03.2020
3	Operator	0.0	12.03.2020
4	Transport and handling	0.0	12.03.2020
5	Installation of the machine	0.0	12.03.2020
6	Installation errors	0.0	12.03.2020
7	Start and stop procedure	0.0	12.03.2020
8	Remote control panel	0.0	12.03.2020
9	General safety information	0.0	12.03.2020
10	Maintenance	0.0	12.03.2020
11	Types of risks and safety pictograms included	0.0	12.03.2020
12	Electrical drawings	0.0	12.03.2020

EC DECLARATION OF CONFORMITY (Annex IIA Machinery Directive 2006/42/EC)



The undersigned:

VTE S.r.l.

Via Luciano Lama, 5
33059 Fiumicello – Villa Vicentina (UD)
Italy

Declares that the machine called MARINE DIESEL GENERATORS of own production:

Model.....Paguro 3SY/4SY/5.5SY

Serial no.....XXXXXXXXXXXXXXXXXX

Year of construction.....2020

to which this declaration relates is in accordance with the following directives:

- **Machinery Directive 2006/42/EC**
- **Low Voltage Directive 2014/35/UE**
- **Electromagnetic Compatibility Directive 2014/30/UE**

And the following harmonized standards

- **UNI EN ISO 12100:2010** **“Machine safety – General design principles – Risk assessment and reduction”**
- **CEI EN 60204-1** **“Machine safety – Electric equipment of the machines. Part 1: General rules”**

We also declare the machine is **CE** marked

The person authorised to compile the Technical File

Vte Srl
Via Luciano Lama, 5
33059 Fiumicello – Villa Vicentina (UD)
Italy

The legal representative

Fiumicello – Villa Vicentina, GG.MM.202

Mr Riccardo Snaidero

INDEX

PAGE

WARNINGS

Premise.....	1
Introduction.....	1
Purpose and contents of the User and Maintenance Manual.....	1
General warnings.....	1
Terminology used in the User and Maintenance Manual.....	2
Obligation to keep the User and Maintenance Manual safe.....	3
Manufacturer Details.....	3
Technical Assistance.....	3
General safety notes.....	3
Warranty.....	4
General safety warnings.....	4
Operator instruction.....	4
Work area.....	4
Additional warnings.....	5
Description of the generator.....	5
Operation principle.....	6
Protections of the generator.....	6
Explosive atmosphere.....	7
Disposal of waste products.....	7
Demolition and disposal of the generator.....	7
Disposal of harmful substances.....	7

1. TECHNICAL SPECIFICATIONS

1	Technical specifications.....	1
1.1	“CE” identification plate.....	1
1.2	Technical specifications.....	1
1.3	Copyright.....	4

2. OPERATING CONDITIONS

2	Operating conditions.....	1
2.1	Containment compartment.....	1
2.2	Minimum air change distance.....	1
2.3	Characteristics of the operating environment.....	1
2.4	Lighting.....	2
2.5	Vibration emission.....	2
2.6	Noise power emission.....	4

3. OPERATOR

3	Operator.....	1
3.1	Operator training.....	1
3.2	Clothing.....	1
3.3	Operator general tasks.....	1
3.3.1	Installer.....	1

	PAGE
3.3.2 Qualified technician.....	1
3.4 Categories of operators authorised to work and intervene on the generator....	1
3.4.1 Installers.....	1
3.4.2 Ordinary maintainers.....	2
3.4.3 Extraordinary maintainers.....	2
3.5 Exposure to hazards and risks from materials.....	2
3.6 Operators training.....	2

4. TRANSPORT AND HANDLING

4 Transport and handling.....	1
4.1 General notions.....	1
4.2 Transport and handling.....	2
4.2.1 Lifting and handling by crane or overhead crane.....	2
4.2.2 Lifting and handling with forklift.....	4
4.3 Unpacking.....	5
4.4 Handling the unpacked generator.....	5
4.5 Storage.....	7
4.6 Shipping.....	7
4.7 Inspection on arrival.....	7

5. INSTALLATION OF THE GENERATOR

5 Installation of the generator.....	1
5.1 Set up for installation.....	1
5.2 Fixing the generator.....	1
5.3 Ventilation.....	2
5.4 External connections.....	3
5.5 Exhaust system installation (on request).....	4
5.5.1 Traditional system.....	5
5.5.2 On-board system with space shortage.....	6
5.5.3 On-board system with long exhaust line.....	7
5.6 Fuel line.....	7
5.7 Installation of the cooling system.....	9
5.7.1 Siphon-break valve.....	10
5.7.2 Raw water intake (on request).....	11
5.8 Electrical connection.....	11
5.8.1 Connection to starting battery.....	11
5.8.2 Main output voltage.....	12
5.8.3 Transfer switch over shore line/generator.....	13
5.8.4 Remote control panel.....	14
5.9 Pre-start inspections.....	15
5.10 Testing.....	15

6. INSTALLATION ERRORS

6 Installation errors.....	1
6.1 Water intake.....	1
6.2 Waterline.....	1

	PAGE
6.3 Exhaust line.....	1
7. STARTING/STOPPING PROCEDURE	
7 Starting/Stopping procedure.....	1
7.1 Checks to be carried out before starting.....	1
7.2 Startup procedure.....	1
7.3 Operating the generator.....	2
7.4.1 Check list.....	2
7.5 Stopping the generator.....	3
8. REMOTE CONTROL PANEL	
8 Remote control panel.....	1
8.1 Control panel description.....	1
8.2 Alarm management.....	2
8.2.1 Reset alarms.....	2
8.3 Electrical connections (8 wires blue cable / control panel).....	3
8.4 Automatic starting device (on request).....	3
9. GENERAL SAFETY INFORMATION	
9 General safety information.....	1
9.1 Preventing electric shock.....	1
9.2 Preventing fire.....	1
9.3 Preventing explosions.....	1
9.4 Accidental power on.....	2
9.5 Explosion of batteries.....	2
9.6 Battery acid.....	2
9.7 High noise.....	2
10. MAINTENANCE	PAGE
10 Maintenance.....	1
10.1 Cutting of the energy sources.....	1
10.2 Ordinary maintenance.....	2
10.2.1 Maintenance state.....	2
10.2.2 General safety warnings.....	2
10.2.3 Functional checks on safety devices.....	3
10.2.4 Maintenance of the electrical system.....	3
10.2.5 General advices.....	4
10.2.6 Maintenance plan.....	4
10.2.7 Ordinary maintenance table.....	4
10.3 Extraordinary maintenance.....	6
10.4 Troubleshootings.....	7
10.5 Maintenance procedures.....	10
10.5.1 Replacing the sea water pump impeller.....	10
10.5.2 Cleaning the sea inlet filter.....	11
10.5.3 Checking engine oil.....	11
10.5.4 Adding engine oil.....	11

	PAGE
10.5.5 Replace the engine oil.....	12
10.5.6 Checking and cleaning of the engine oil filter	12
10.5.7 Cleaning of the fuel filter in entrance.....	13
10.5.8 Cleaning of the air filter.....	14
10.5.9 Emptying of the tank and replacing the outlet filter.....	15
10.5.10 Generator cleaning.....	15
10.5.11 Maintenance of the batteries.....	15
10.6 Generator inactivity.....	16

11. TYPES OF RISKS AND SAFETY PICTOGRAMS INCLUDED

11	Types of risks and safety pictograms included.....	1
11.1	Risks of a mechanical nature.....	1
11.1.1	Generator stability.....	1
11.1.2	Breakage dangers during the functioning of the generator.....	1
11.1.3	Dangers and risks caused by flying objects.....	1
11.2	Design and physical features of safety guards.....	2
11.3	Safety pictograms on-board the generator.....	2
11.4	Electrical risks.....	2
11.5	Other nature risks or residual risks.....	3
11.5.1	Risk of fire.....	3
11.5.2	Risk of explosion.....	3
11.5.3	Dangers and risks from toxic exhaust gases.....	3
11.5.4	Dangers and risk arising from parts subject to extreme temperatures..	3

12. ELECTRICAL DRAWINGS

12	Electrical drawings.....	1
12.1	Paguro 3SY/4SY electrical drawing.....	1
12.2	Paguro 5.5SY electrical drawing.....	2
12.3	Alternator electrical drawing Paguro 3SY/4SY.....	3
12.4	Alternator electrical drawing Paguro 5.5SY.....	4

ATTACHMENTS

Attachments.....	1
------------------	---

WARNINGS

PREMISE

This *User and Maintenance Manual of the Marine Diesel Generator mod. Paguro 3SY/4SY/5.5SY* contains the instructions that allow the operator to use the generator to the best of its operational capabilities and provides all necessary information and instructions to operate in observance of the Machinery Directive 2006/42/EC.

Its accurate design eliminates or significantly reduces any risks to the user being the operator.

It is therefore possible to affirm that the *Marine diesel generator* is safe when used correctly.

The user is required to strictly follow the instructions provided herein and particularly those pertaining to safety regulations.

A single copy of the User and Maintenance Manual is provided when the generator is delivered and installed. If the operator is not able to keep the manual safe without ruining it, it is necessary to prepare a photocopied copy of it. In any case it is possible to contact the Manufacturer to ask for another copy.

This manual is an integral part of the generator and must be kept safe along with the generator with the utmost care and follow this last one in each and every eventual property steps.

The **VTE S.r.l** company will not be held liable for any inaccuracies in the instruction manual if due to printing errors or inadvertent errors.

Furthermore, the **VTE S.r.l** company reserves the right to make modifications to their generators as it deems necessary or useful without undermining the essential characteristics.

INTRODUCTION

Purpose and contents of the User and Maintenance Manual

This User and Maintenance Manual describes the *Marine Diesel Generator mod. Paguro 3SY/4SY/5.5SY* for the production of electricity on board.

The generator can operate within the limits indicated in the cap. 1 "TECHNICAL SPECIFICATIONS".

For an easy consultation of the manual, the *Marine Diesel Generator* will hereinafter simply be referred to as the "generator". The manual is written to put operators in a position to:

- gain knowledge of issues relating to the generator.
- work safely.

The manual contains therein the user instructions and maintenance advice, together with rules on safety and accident prevention.

General warnings

Before proceeding with the generator starting procedure the operator must read carefully this manual and must have vested a deep knowledge of the technical specifications and of the generator commands.

They contain important information for:

- the safety of people involved in installation, start up and maintenance;
- the safety and efficiency of the generator;

Operation of the generator is not allowed if there is any doubt regarding the correct interpretation of the instructions. Contact the Manufacturer or service centre if further explanation is required.

The Manufacturer is available to provide technical training at the Customer's facilities.

Requests, time, costs and arrangements must be agreed in advance.

Terminology used in the User and Maintenance Manual

- **WORK AREA** The operating area is defined as the area for the installation of the generator.
- **INSTALLATION:** Installation is defined as the mechanical and plant integration of the generator on the boat.
- **COMMISSIONING:** Commissioning is defined as the functional verification of the installed system.
- **DEMOLITION AND DISPOSAL OF THE GENERATOR:** Decommissioning is defined as the mechanical removal of the generator. Disposal of the generator is defined as the activity of demolition and disposal of the components that make up the generator.
- **MAINTENANCE AND REPAIR:** Maintenance and repair work is defined as the periodic inspection and/or replacement of parts or components of the generator to identify the cause of a failure that has occurred, which ends with the restoration of the functional conditions of the project.
- **IMPROPER USE:** Improper use is intended as the use of the generator outside the limits of the technical documentation.
- **DANGEROUS AREA:** Any area inside and/or near the generator where a person is exposed to a risk to their safety or health.
- **EXPOSED PERSON:** Any person who is wholly or partly in a hazardous area.
- **OPERATOR:** the person responsible for operating the generator each within the limits of the tasks assigned to it.
- **INSTALLER:** the person responsible for performing mechanical and plant installation, calibration, commissioning, each within the limits of the tasks assigned to it.
- **QUALIFIED TECHNICIAN:** a specialised person, employed by the Manufacturer or by the authorised service centre, specifically trained and authorised to make interventions of extraordinary maintenance (of electric or mechanical nature) or repairs which require a particular knowledge of the generator, their functioning, of the safety devices provided and of its modes of intervention.

In the following manual will be defined the tasks, the skills and the work limitations of the various operators.



Installers must not perform operations reserved for maintenance technicians or qualified technicians. The Manufacturer will not be held liable for damages arising from the failure of such prohibition.

Certain activities (such as installation and commissioning, initial calibration and registration, repair, overhaul, moving and decommissioning of the generator) require the presence of qualified technicians or the authorized service centre.

To understand the instructions (text and pictures), the generator operators must meet (or acquire, through training and instruction) at least the following requisites:

- a sufficient level of general and technical knowledge to read and understand the content of those parts of the manual that concern him/her, and to be able to interpret the drawings and diagrams correctly;
- ability to understand and interpret the symbols, safety pictograms;
- knowledge of the main accident prevention and technological regulations;
- Know what to do in an emergency, and how to use Personal Protective Equipment (PPE) correctly.

Maintenance technicians must possess the same requisites and also have a good level of technical knowledge obtained by a professional qualification and/or adequate experience in their field of work.

They must also have the specific and specialized technical knowledge (mechanical, electrical) that are required for the tasks proposed in the User and Maintenance Manual. Important! The MANUFACTURER must:

- verify that staff actually possess the required level of knowledge to read and fully understand the User and Maintenance Manual.
- carry out practical training and ensure, even using tests, that the appointed operator is able to operate the generator properly and safely.

Obligation to keep the User and Maintenance Manual safe

You must keep this manual and all attached documents in an easily accessible place, near the generator, and known to all operators.

The operators and maintenance staff must be able to quickly locate and consult, in any situation, the User and Maintenance Manual.

THE MANUAL IS AN INTEGRAL PART OF THE GENERATOR FOR SAFETY REASONS. Therefore:

- must be kept intact (in all its parts).
- must follow the generator in each and every eventual property passes until its demolition (even when rented, etc.).

3

Manufacturer Details**VTE S.r.l.**

Via Luciano Lama, 5
33059 Fiumicello – Villa Vicentina (UD) - Italy

Telephone: +39 0431 96488

E-Mail: info@volpitemcno.com

Website: www.volpitemcno.com

Technical Assistance

The Technical Assistance Service is available for Customers to:

- provide clarifications and information;
- planning possible interventions at the Customer's premises, by sending specialized technical staff;
- send spare parts/components.

Requests can be made directly to the Manufacturer, to the Official Distributor or the Authorized service point; they can be forwarded by email. For any technical service or spare parts order, always quote the serial number of the generator.

**IMPORTANT!**

- **the Customer-installer is always required to buy either original parts or the ones authorized in writing by the Manufacturer;**
- **the assembly and removal of parts must be entrusted and performed by qualified technicians, and carried out in accordance with the Manufacturer's instructions;**
- **the use of non-original parts and/or defective or incorrect assembly relieve the Manufacturer of any liability AND VOID THE WARRANTY.**

General safety notes

VTE S.r.l. cannot be held responsible for injuries and damages of any kind to persons/things or other, caused by the non-observance of the indications given in this document or by the improper use of the generator.

The modification/deletion of the apparatuses in the generator or the modification/deletion of the protections and safety devices provided with the generator, built by **VTE S.r.l.**, involve the immediate warranty loss.

Warranty

The company **VTE S.r.l.** guarantees the generator according to the terms and times provided on the sales contract.

The warranty does not cover wear parts such as brass, gaskets, etc.

The warranty is void if the failure/damage to the generator is caused by incorrect installation, tampering, unauthorized service or the use of non-genuine spare parts.

Company **VTE S.r.l.** has no other obligations or fulfilment than what above stated.

For any technical communication with **VTE S.r.l.**, always use the contacts listed in this User and Maintenance Manual.

GENERAL SAFETY WARNINGS

The purpose of this section is to inform operators (installers and maintainers) of any risks and dangers of particular relevance and of general and specific precautions for their elimination or neutralisation.

This section contains information and instructions on:

- dangerous situations that may occur during installation and maintenance of the generator;
- guards and safety devices and their proper use;
- residual risks and procedures to adopt (general and specific precautions to eliminate or limit them).



For clarity of information, some illustrations in this manual show parts of the generator without protection guards. NEVER USE THE GENERATOR WITHOUT PROTECTIONS.

Operator instruction

Installers and maintainers must be familiar with the following before operating on the generator:

- the function and use of the controls;
- the position, the function and the use of all safety devices;
- the characteristics of the generator;
- this manual and how to consult it.

They also must:

- have received adequate training.
- have received written permission to use the generator.

If these requirements are not observed the Manufacturer declines each responsibility.

Any tampering or unauthorized replacement of one or more parts of the generator, the use of accessories, tools, consumables other than those prescribed by the Manufacturer, can result in the risk of injury and accordingly relieves the Manufacturer of any civil or criminal liability.

Work area

- The work area must be NEVER occupied by boxes, generator tools, or other objects, which can create obstruction resulting in failures. Nothing should interfere with the freedom of movement of the operators; furthermore, in emergency situations, staff must have unrestricted and quick access to the generator.
- Access to the work area is forbidden to people who are not directly involved in installation or maintenance.
- The compartment in which the generator is installed must be kept clean and well ventilated.

It is responsibility of the operator to enforce the rules and to report any non-observance to those in charge.

ADDITIONAL WARNINGS

At this point in the User's and Maintenance Manual it is useful to provide a list of general safety requirements for the most common operating situations:

- respect the indications of the safety pictograms on the generator board;
- before starting the generator, make sure that no one is performing maintenance on the generator.
- maintenance must be entrusted only to authorized personnel who must first put the generator in maintenance status (see Chap. 10 "Maintenance").
- under no circumstances should the guards (sound-absorbing enclosure) be removed while the generator is running;
- it is absolutely forbidden to anyone to use the generator for a purpose other than the one expressly intended.



Any other use of the generator not provided for in this operation and Maintenance Manual is considered "IMPROPER USE".

In this case, the manufacturer declines all responsibility in relation to any damage caused to property and/or persons and considers that any warranty on the generator and the accessories supplied has lapsed.

DESCRIPTION OF THE GENERATOR

The Marine diesel generator mod. Paguro 3SY / 4SY / 5.5SY is a generator designed to produce electricity on board boats. This generator has been designed and built to be installed on a boat, (able to house the generator in terms of size and weight).

The Paguro generator consists essentially of:

- Soundproofing capsule made of reinforced fiberglass with composite stratification and covering in high-density sound-absorbing material for the reduction of the sound emission due to the internal combustion engine;
- Double anti-vibration system, internal with 4 soft supports and external with 4 semi-elastic supports;
- Endothermic engine, powered by diesel, with 2/3/4 cylinders (depending on the model) and cooled by means of a heat exchanger, whose purpose is to transform the energy of the input fuel into mechanical energy (rotation of the shaft);
- Synchronous alternator, brushless and condenser regulation, water-cooled by an exchanger, driven by the shaft of the endothermic engine, equipped with a battery charger for a dedicated starting battery. The alternator converts mechanical energy into electrical energy;
- Electrical box equipped with alternator thermal protection reset button and capacitors;
- Heat exchanger provided with tube nest;
- Fresh water endothermic engine cooling system with heat exchanger;
- Self-priming water pump;
- Remote control panel with LCD display, for managing the operation of the generator;
- Manual engine oil extraction pump;
- Sea water and gas exhaust terminal with overtemperature switch.

The generator is easy to manage in maintenance and cleaning operations, according to the latest accident prevention regulations.

The generator is supplied with a spare parts kit (impeller and impeller seal).

Operation principle

The operation of the generator, for the generation of energy, develops through the following phases:

1. The fuel arrives at the endothermic engine where, by means of the combustion process, it is transformed into mechanical energy;
2. Mechanical energy is converted by the alternator into electrical energy;
3. The self-priming pump draws sea water for successive cooling of the following components:
 - Engine oil sump, via a contact exchanger;
 - Alternator;
 - Coolant contained in the engine cooling exchanger;
 - Exhaust terminal.
4. Exhaust gases and cooling water are expelled outside through the terminal.

PROTECTIONS OF THE GENERATOR

The generator is protected by a multilayer fiberglass capsule, lined internally with sound-absorbing material, consisting of:

- N.1 lower containment element of the generator equipped with anti-vibration system.
- N.2 upper elements with interlocking profiles, held together by silicone elastic bands.

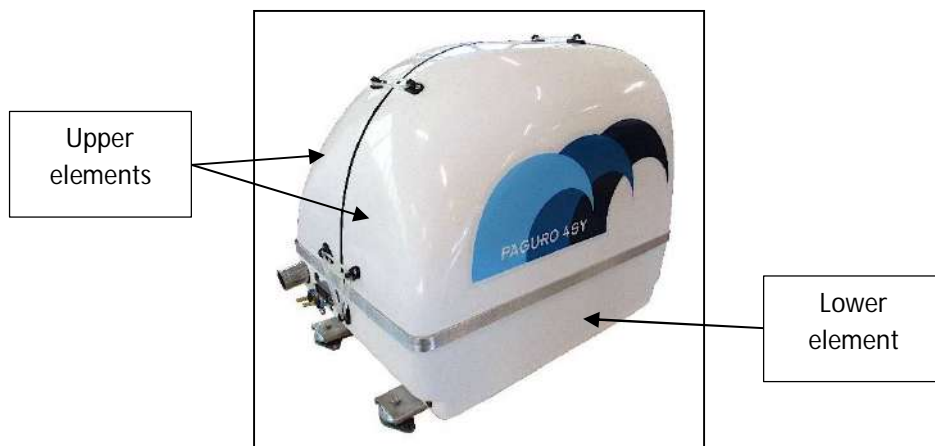

Lower protection of the generator



Lateral elastics



Upper elastics

EXPLOSIVE ATMOSPHERE

This generator and its devices are made in standard version and can therefore not be installed and used in premises where the concentration of dust may exceed acceptable limits and create potentially explosive atmospheres.

DISPOSAL OF WASTE PRODUCTS

During normal operation, the generator generates waste or waste substances that must be collected, recycled or disposed of in accordance with current laws in the country in which it is installed and used. These substances are basically:

- engine oil;
- refrigerant liquid.
- exhausted lubrication oils;
- replaceable wearable parts.

To proceed with the disposal of these substances, please refer to the Regulations in the Country of residence in accordance with the regulations in force and act accordingly.

DEMOLITION AND DISPOSAL OF THE GENERATOR

Once the generator has reached the end of its technical life, it must be put out of service so it will not be used for the intended purpose and it is not possible to reuse parts and materials. The generator must be safely disabled and demolished. **VTE S.r.l.** company assumes no liability for damages to things or people arising from the reuse of individual parts of the generator for functions other than the original.

1. *Before proceeding with demolition, it is necessary to empty the generator from all liquids;*
2. *Inform the responsible authorities for this task by written communication in accordance with the regulations in force in the individual Country;*
3. *Dismount the generator depending on the various components, using tools and devices that can normally be found in maintenance stores. Separate potentially hazardous components such as:*
 - **Plastic materials, polymer-based materials, etc;**
 - **Electrical components, cables, ecc...;**
 - **Metal parts by type, such as aluminium, steel, etc...**
4. *After having received the authorization from the above authorities, proceed to the disposal of the components in accordance with applicable laws and Regulations in this area.*

Always keep in mind that the disposal of toxic and harmful waste is subject to special rules according to the country of affiliation. Before doing such operations, you must be aware of these rules.

Disposal of harmful substances

To proceed with the disposal of these substances, please refer to the Regulations in the Country of residence in accordance with the regulations in force and act accordingly.

Any irregularity committed by the Customer before, during or after the scrapping and disposal of the generator components, in the interpretation and application of the relevant Regulations in this matter, is solely responsible for the Customer himself.

If you have any questions or other information, please contact the technical assistance service of **VTE S.r.l.**

1. TECHNICAL SPECIFICATIONS

1.1 "CE" IDENTIFICATION PLATE

The picture below illustrates the *identification plate* of the generator. It is attached to the generator's capsule and shows:

- Manufacturer identification data;
- CE mark;
- Model;
- Type;
- Serial number;
- Year of construction.

The plate bears the **CE** symbol, certifying that the generator is compliant with the main health and work safety regulations in the European Community as well as with **Machinery Directive 2006/42/EC**.

			
VTE Srl Via Luciano Lama, 5 - 33050 - Fiumicello (UD) – Italia Tel: +39 0431 96488 - e-mail: info@volpitemco.com			
MODEL		<input type="text"/>	
TYPE		<input type="text"/>	
SERIAL NUMBER		<input type="text"/>	
YEAR OF CONSTRUCTION		<input type="text"/>	

“CE” identification plate

1.2 TECHNICAL SPECIFICATIONS

In the following tables are listed the Generator technical characteristics in Your possession (please refer to the individual model):

GENERATOR SPECIFICATIONS				
DESCRIPTION	U.M.	PAGURO 3SY	PAGURO 4SY	PAGURO 5.5SY
Width	(mm)	429	429	460
Depth	(mm)	615	615	660
Height	(mm)	525	525	600
Weight (incl. capsule)	(Kg)	90	90	110
Acoustic output	DB(A)	53	53	53
Yanmar engine model	-	L70N5	L70N5	L100
Number of cylinders	-	1	1	1
Engine oil quantity	(Kg)	1,05	1,05	1,60

GENERATOR SPECIFICATIONS				
DESCRIPTION	U.M.	PAGURO 3SY	PAGURO 4SY	PAGURO 5.5SY
Engine speed rotation	giri/min	3000 (50 Hz)	3000 (50 Hz)	3000 (50 Hz)
Continuous electrical power	50 Hz	3 kVA-3 kW	4 kVA-3,5 kW	5 kVA-4,5 kW
Single phase output voltage	V	230 (50 Hz)	230 (50 Hz)	230 (50hz)
Peak current	A	36 (50 Hz)	45 (50 Hz)	60 (50Hz)
Electric start and stop system	V	12	12	12
Specific diesel fuel consumption	l/kW/h	0,35	0,35	0,35

INTERNAL DIAMETERS SPECIFICATIONS				
DESCRIPTION	U.M.	PAGURO 3SY	PAGURO 4SY	PAGURO 5.5SY
Water inlet	(mm)	13 x 1/2"	13 x 1/2"	13 x 1/2"
Exhaust line	(mm)	40	40	40
Diesel fuel supply	(mm)	8	8	8
Diesel fuel return	(mm)	8	8	8
Anti-siphon valve	(mm)	13	13	13

REMOTE CONTROL PANEL SPECIFICATIONS		
DESCRIPTION	U.M.	VALUE
Dimensions (L x P x H)	(mm)	99.9 x 69.6/108.4
Weight	g	≈ 290
Electronic protection	IP	65
Electronic protection - connectors	IP	65
Operating temperature	°C.	10 ÷ 60
Power supply	(Vdc)	8/30
Consumption (pre alternator excitation)	mA	≈ 122
LCD screen resolution	pixels	128 x 1/64

Below is the Generator with a basic description of the main units and components installed.

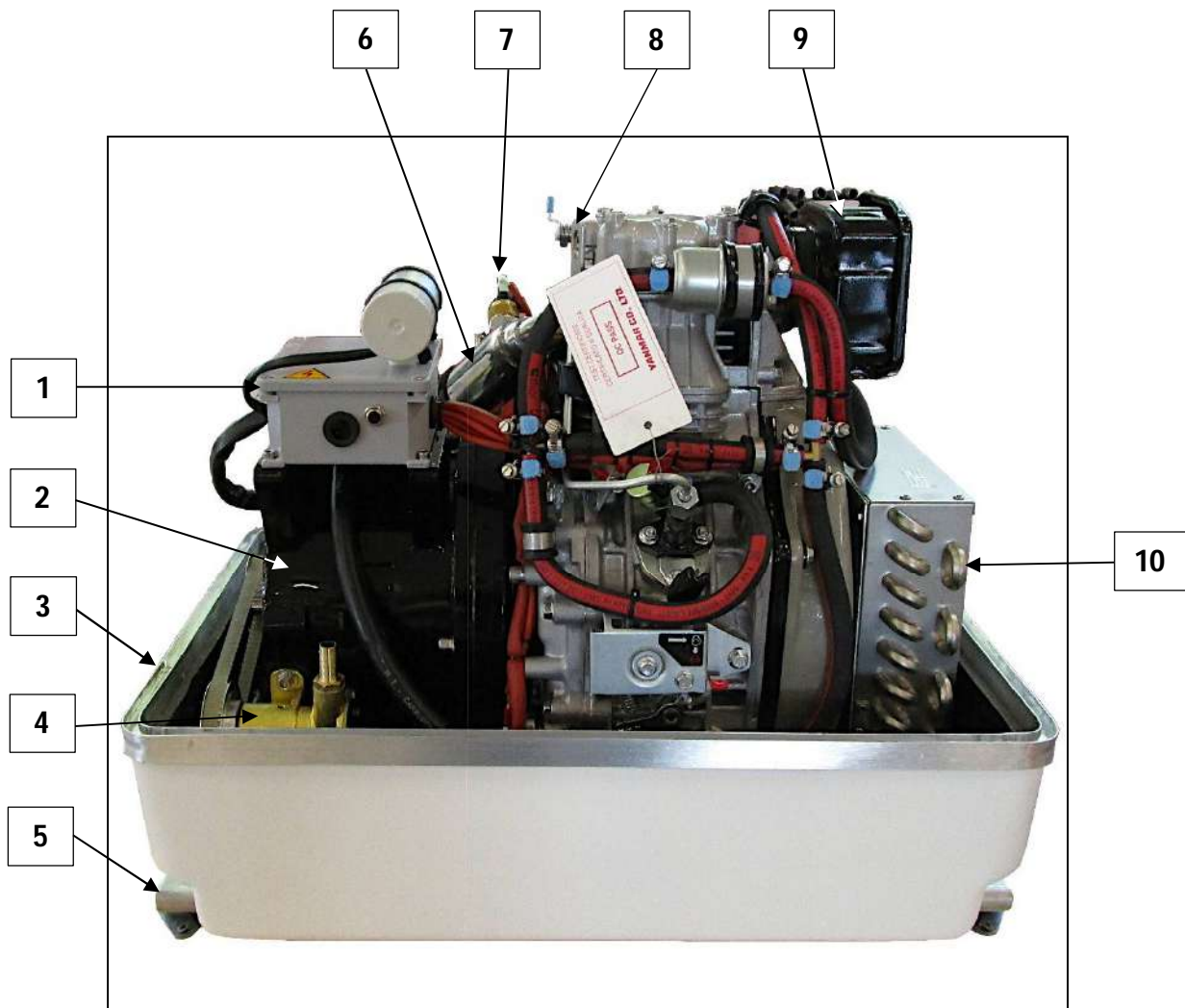

Internal Paguro 3 SY / 4 SY / 5.5SY

Key:

- | | |
|--|---------------------|
| 1. Electrical box ; | 8. Lifting eye; |
| 2. Alternator; | 9. Air filter; |
| 3. Lower capsule; | 10. Heat exchanger. |
| 4. Seawater pump; | |
| 5. Bracket with soft vibration supports; | |
| 6. Exhaust manifold; | |
| 7. Temperature switch on exhaust; | |

1.3 COPYRIGHT



ATTENTION! All rights are reserved under the "INTERNATIONAL COPYRIGHT CONVENTIONS", it is forbidden to reproduce any part of this manual in any form, without the express written permission of the Manufacturer VTE S.r.l.

The contents of this guide are subject to change without notice. Every care has been taken to collect and verify the documentation contained in this manual in order to make the guide as complete and understandable as possible.

Nothing in this publication shall be interpreted as warranty or explicit condition or implicit-included condition, but not limited to the warranty of suitability for a particular purpose. Nothing in this publication shall also be interpreted as modifying or asserting the terms of any purchase agreement.

2. OPERATING CONDITIONS

2.1 COMPARTMENT

Paguro generator has been designed and manufactured to operate on board boats and in a well ventilated and closed compartment, where there are no danger of explosion or fire.

The *Marine generator* containment compartment must ensure minimum distances for correct air replacement.

2.2 VENTILATION

The minimum distances indicated in the image below are recommended around the generator. The environment in which the generator is installed must be naturally ventilated and have more than one opening to the outside. Select a compartment that allows adequate air flow for the engine air intake.

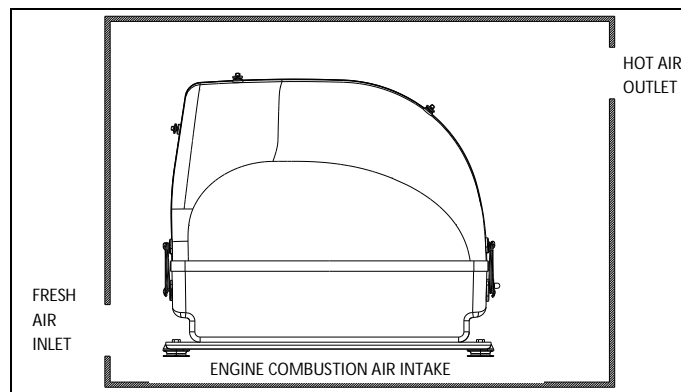

Generator compartment - example

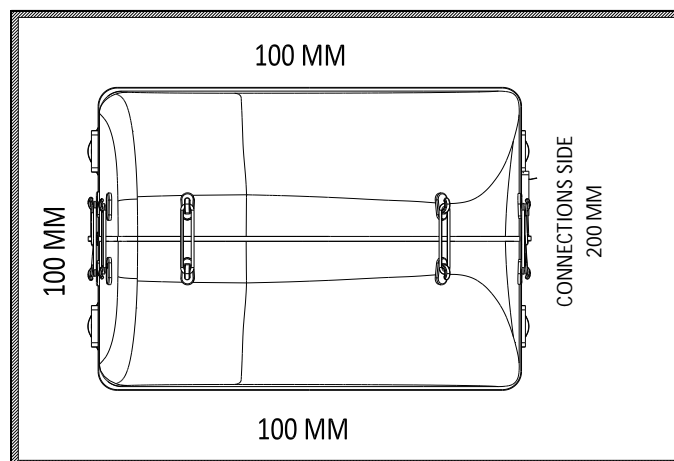

Minimum air change distance

2.3 CHARACTERISTICS OF THE OPERATING ENVIRONMENT

This generator has been designed and realized to work only at the environmental conditions listed here below:

- Area temperature range: value between **+5 °C and +40 °C**.
- Maximum RH without condensation: **90% at 20°C**.

2.4 LIGHTING

The generator, once installed, must have sufficient natural light to ensure adequate visibility to the operator during maintenance.

It is the task of the operator to equip the boat with suitable artificial lighting systems such as to ensure adequate lighting on the generator in case of maintenance work. The lighting must be uniform and ensure good visibility. Work with insufficient natural light may require the use of local lighting fixtures. It is to be remembered that the devices must not be able to generate additional risks.

2.5 VIBRATION EMISSION

The entire generator has been designed and manufactured to limit the generation and distribution of vibrations produced during normal operation, which could compromise the stability and/or operation of the generator. In particular, Paguro generators use a dual system to minimize the vibrations transmitted to the hull:

1. N.1 **Internal** system consisting of:
 - N.2 anti-vibration brackets.
 - N.4 anti-vibration semi-elastic supports and respective anti-vibration fixing screws.

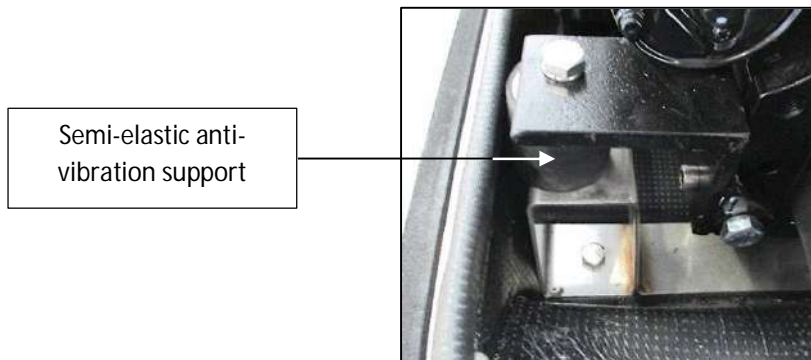

Bracket and anti-vibration support (inside generator)

2. N.1 **Internal** system consisting of:
 - N.2 anti-vibration brackets on which the entire generator rests.
 - N.4 anti-vibration semi-elastic supports and respective anti-vibration fixing screws.

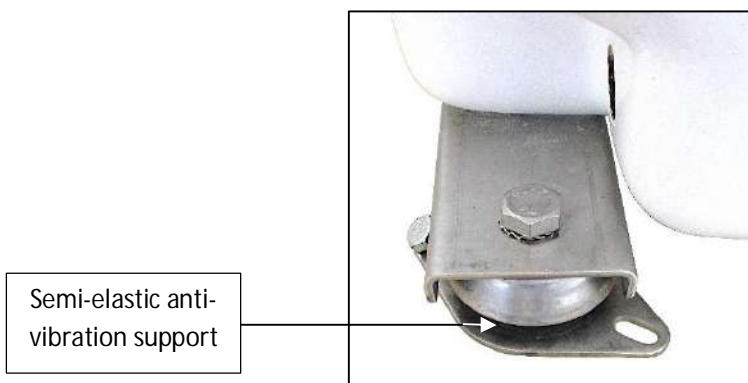

Bracket and anti-vibration support (outside generator)

NOTE: The external shock-absorbers supports already have holes for securing the generator to the boat.

A further solution to increase the dampening of vibrations is adding a plate between the generator and the boat's mounting platform. This will also improve the sound insulation

This platform must have the following requirements:

- At least 30 mm thick.
- Its own weight is greater than 10 kg to behave like a mass in opposition to the vibrations induced by the engine.

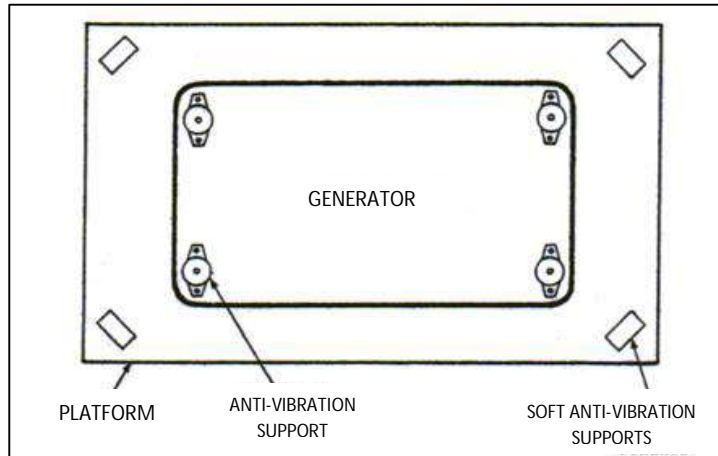

Anti-vibration supports on platform

The vibration dampers of the oscillating platform (not included in the scope of supply) must not be aligned with the soft vibration dampers located under the generator. Depending on the available space, the greater the distance between the vibration dampers, the better the result is.

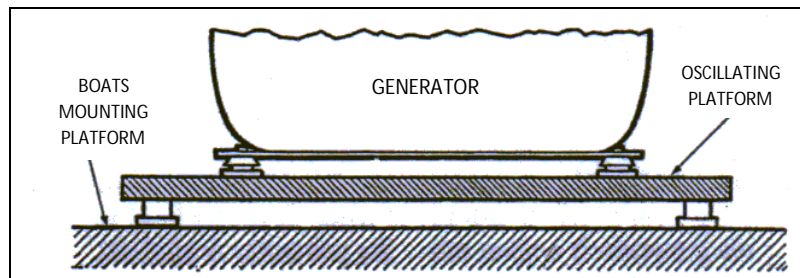

Abnormal vibrations reveal mechanical problems (e.g. loose belts).

In this case you must intervene following the maintenance procedures described in this manual (see Chap. 10 "Maintenance"). If the phenomena continue, contact the manufacturer or the service centre listed in Chapter "WARNINGS" immediately and **stop the generator from operating until the problem is resolved.**

2.6 NOISE POWER EMISSION

The Paguro generator has been designed and manufactured to significantly reduce the sound power level. In particular, the generator adopts a soundproofing capsule to limit the emission of the noise generated by the internal endothermic engine into the surrounding environment. The capsule is made of fiberglass and is internally coated with sound-absorbing material.



Sound-absorbing coating– Internal lower side

The maximum sound pressure value detected during the various samplings is less than 70 dB (A). In any case, the factors determining the exposure level include the duration of the exposure, the characteristics of the installation point and other adjacent sources of noise. Abnormal sounds reveal mechanical problems (e.g. loose belts). In this case you must intervene following the maintenance procedures described in this manual (see Chap. 10 “MAINTENANCE”). If the phenomena continue, contact the Manufacturer or the service center listed in chapter “WARNINGS” immediately and **stop the generator from operating until the problem is resolved.**

3. OPERATOR

This chapter is an information and precautionary source of technical precautions that the operator must observe when performing his/her functions (installation and maintenance).

3.1 OPERATOR TRAINING

It is the responsibility of the employer to provide the operator with the necessary information for the installation and maintenance of all generator components and to provide the operator with appropriate Personal Protective Equipment. The User and Maintenance Manual is an essential document to operate in conditions of absolute safety, accordingly it is **COMPULSORY to read the contents before using the generator.**

3.2 CLOTHING

The operator must wear clothing that is appropriate to the operations he must carry out on the generator.



During the installation and maintenance operations of the generator it is essential to use:

- Protective gloves
- Overall;
- Otoprotectors (where provided)
- Safety shoes.

3.3 OPERATOR GENERAL TASKS

3.3.1 Installer

The main task assigned to the installer is to perform the mechanical and plant installation of the generator, to perform the calibrations, the routine maintenance, the commissioning and to verify that the process of production of electrical energy is correctly carried out.

3.3.2 Qualified technician

The qualified technician has an in-depth knowledge of how to install, operate, repair, extraordinary maintenance of the generator and has technical qualifications, such as:

- a technical training which authorizes to operate according to safety standards in relation to the dangers that the presence of electric current may represent;
- technical training or specific instruction relating to safe maintenance procedures;
- training in basic first-aid interventions.

3.4 CATEGORIES OF OPERATORS AUTHORISED TO WORK AND INTERVENE ON THE GENERATOR

The following are the categories of operators that are authorized to operate on the generator for installation or maintenance purposes.

3.4.1 Installers

This category of operators must be instructed and authorized to install the generator.

Expected tasks:

- mechanical installation of the generator (positioning, fixing,..);
- plant installation of the generator;
- commissioning the generator.

3.4.2 Ordinary maintainers

They are trained and authorized technicians for ordinary maintenance, each for its (mechanical or electrical) skills:

- **mechanical maintenance workers:** they are technical workers, trained and authorized to perform the maintenance of mechanical parts and fluidic liquid/aeriform systems.
- **electric maintenance workers:** they are technical workers, trained and authorized to perform the maintenance of electric/electronic parts, apparatus and systems.

They are authorized for operation, ordinary maintenance and cleaning, i.e.:

Tasks during operation:

- restoration of normal operating conditions after a breakdown stop;
- verification of the correct operation of the generator and of its process of production of electric energy;
- perform typical installer tasks.

Tasks foreseen during maintenance:

- Checking the parts subject to wear and carrying out the replacement operations.

3.4.3 Extraordinary maintainers

They are qualified and specialized technicians (dependent on the manufacturer or authorized service centre), trained and authorized for extraordinary maintenance and for operations of a complex and/or dangerous nature.

During maintenance and/or disassembly they perform:

- repair of electrical and/or mechanical faults;
- replacement of broken or worn parts;
- replacement of components and safety devices;
- any work on the electrical part (only necessary in the event of a breakdown);
- all the typical operations of installers and ordinary maintainers (conversely, an ordinary maintainer cannot perform the tasks assigned to an extraordinary maintainer).

3.5 EXPOSURE TO HAZARDS AND RISKS FROM MATERIALS

The materials used to build the generator do not create any hazards or risks for operators. On the other hand, the following materials used and/or generated by the generator during operation may be dangerous for the environment if they are not treated correctly:

- used lubricants (contact the appropriate disposal Consortium if necessary);
- replaceable wearable parts.
- exhausted engine oil.
- Refrigerant liquid.
- fuel.

3.6 OPERATORS TRAINING

The employer, the managers and the appointed members of staff, each according to their respective qualification and experience, must ensure that each operator receives adequate training regarding safety and health, with particular reference to their tasks.

Training must be provided at the following occasions:

- when the individual is hired;
- when the individual is moved or assigned new duties;

Training must be periodically repeated as the risks evolve, i.e. when new risks arise due to changes in generator or components configuration.

4. TRANSPORT AND HANDLING

4.1 GENERAL NOTIONS

The lifting, handling, transport of the generator must be assigned exclusively to operators skilled in those types of operations (slingers, crane operators, forklift operators, signallers). Operators must also be:

- aware of the kind of loads that require lifting, the operations that need to be carried out and the procedures set forth in the User and Maintenance Manual;
- authorised;



WARNING! During the operations the workers must wear Personal Protective Equipment, helmets, gloves, accident-prevention shoes, overalls or other devices eventually needed by the law in force, according to the type of the operations to do.



WARNING! Operators must comply with the requirements and prohibitions required by law in force for lifting and transport; among these we underline the following general behaving rules:

- move away from loads before lifting and lowering them;
- prohibit the access of unauthorized people to the work;
- during operations maintain the safety distance from the lifted load.



WARNING! Neglecting the precautions indicated above, can cause serious injuries and/or accidents resulting in damage to equipment and injury to operators.

In severe cases, accidents can cause death of workers.

4.2 TRANSPORT AND HANDLING



Before being transported, the generator must be emptied of all the fluids contained in the generator in order to prevent the escape of any dangerous substances (e.g. engine oil, coolant).

The generator is sent assembled, anchored to a pallet by means of the fixing holes positioned on the plates of the generator itself and inserted in a wooden box, provided with lower crossbars.

Optional items are shipped in a cardboard box attached, by strapping, to the main box.



Generator packaging



Generator packaging + optional

The packaging ensures the preservation and integrity of the generator during transport, preserving it against mechanical, climatic, and biological influences that may occur during transport.

Upon arrival, check that the generator has not been damaged during transport and that all components are included in the scope of delivery, including the User and Maintenance Manual if it is included in the packaging.

WARNING! All means employed for handling must be suitable for lifting the generator, having in mind:

- the shapes and sizes;
- the mass (weight) and its distribution;
- the lifting points provided.



WARNING! Personnel trained for this reason must be employed for these operations (slingers, crane operators, lift truck drivers, etc.). Partnering to the operator one person in charge of the signalling, because the space of the transported generator or the packages might not allow a sufficient visibility to the driver.

4.2.1 Lifting and handling by crane or overhead crane

General recommendations:

- a) Check that the lifting hooks and ropes are suitable for the weight to be lifted.
- b) Make sure that there is enough space for lifting and handling with the crane.
- c) Take all necessary precautions when lifting and handling to prevent damage to persons and the unit to be handled.
- d) Check crane safety before use.
- e) Stay at a safe distance when lifting and handling.
- f) Lift the packaging slightly and make sure it is in balance and that the ropes/chains are tight.
- g) Lift the packaging as little as necessary for the unloading and move it avoiding any shock or impact.
- h) Place the packaging at the designated location.
- i) Remove the ropes/chains from the crane/overhead crane hook and from the packaging.

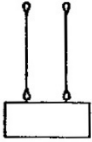
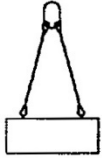
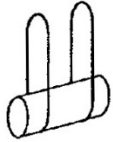
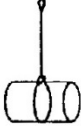
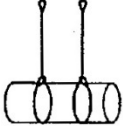
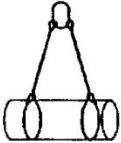
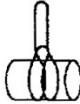
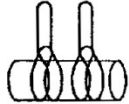
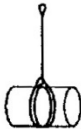
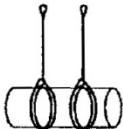
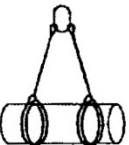
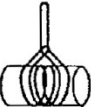
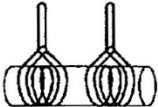
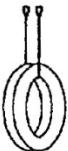
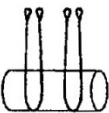
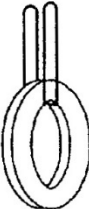
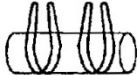
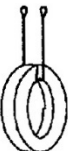
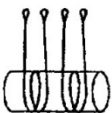
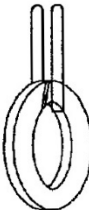
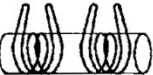
Slinging method	Type of sling				
	Sling single leg		Sling of two legs	Sling double leg	
	simple	double		simple	double
VERTICAL					
CHOKER HITCH					
DOUBLE WRAP CHOKER HITCH					
SINGLE/TWO SINGLE BASKET HITCH					
DOUBLE WRAP BASKET HITCH					

4.2.2 Lifting and handling with forklift

This type of handling is used to move the packed generator.



WARNING! Always check where the forks rest under the box.

To lift with a forklift, follow these steps:

- Insert the fork of the truck under the wooden box, taking care that they protrude from the opposite side.
- Lift the generator slightly and make sure that the load is in balance.
- Lift the generator to the minimum and move it away without jolts or shocks.
- Place the box at the designated location.
- Remove the forks from under the box.



Fork insertion



Fork insertion



WARNING!

- Unloading, lifting and handling operations must be carried out by qualified personnel specially prepared for these operations.
- Prevent multiple people from working on the generator at the same time without coordination, resulting in a hazardous situation.
- Make sure the dimensions, weight and centre of gravity of the generator and its packaging.



The packaging must be lifted with a forklift truck that has the capacity and length of the forks appropriate to the nature of the load to be handled.

During the use of the forklift truck the operator must also:

- check that the packaging is balanced.
- lift the packaging far enough to move it.

WARNING! During the transport, protect the packaging from overturning.

WARNING! In any case the packaging must never be transported, stocked or stationed in an oblique position.

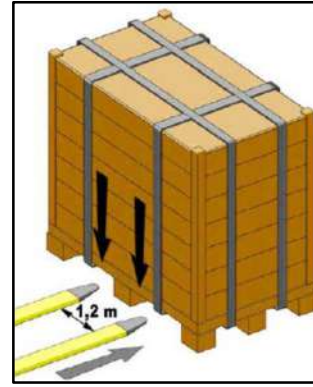
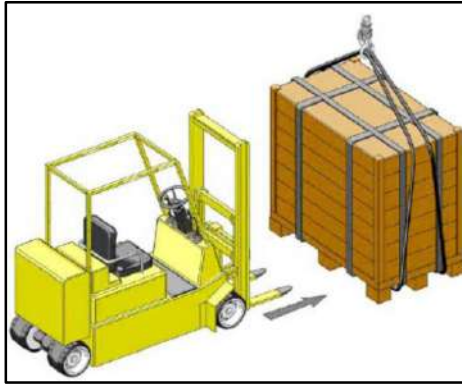

4.3 UNPACKING

Once the generator has been unloaded from the means of transport, unpack it according to the following procedure:

1. Remove the optional cardboard box strapping (if equipped);
2. Remove the top cover of the wooden case using a hammer with a nail puller;
3. Now remove the side covers;
4. Remove the screws that secure the generator to the pallet.



WARNING! Always wear hand protection gloves. Always pay close attention to any protruding nails.

All packaging elements must be collected and sent to collection points for proper recycling.



4.4 HANDLING THE UNPACKED GENERATOR

Once unpacked, the generator can be moved with a suitable lifting device capable of withstanding its weight and dimensions (shown in the table in para. 1.2 "Technical specifications") in such a way as to avoid damage to the same, to persons or to surrounding things.

Follow these guidelines:

- Remove the silicone elastics on all sides of the generator;
- Remove the 2 upper guards and place them in a safe place;
- Sling the generator using a suitable lifting device (e.g. hoist) of suitable capacity, attaching the chains in the 2 lifting eyes provided on the generator;

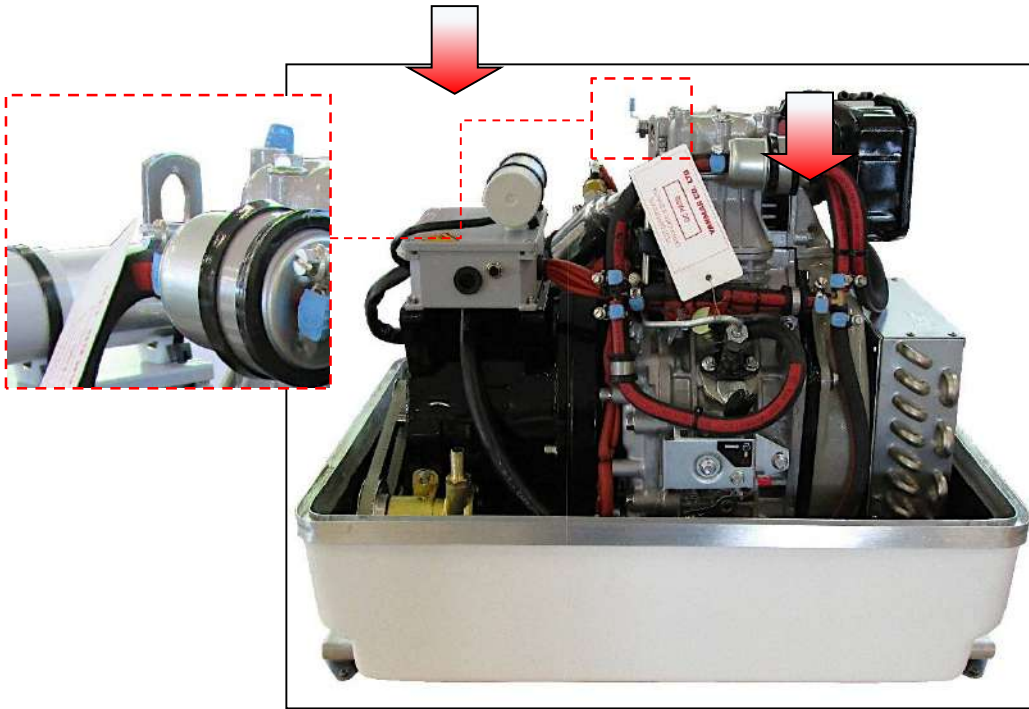

Paguro 3SY / 4SY / 5.5SY lifting point

- Tension the ropes/chains slightly and check that they do not exert any pressure on the structure or components of the generator. Failure to wait for this point can cause serious damage to the generator;
- Slowly lift the unit.
- Place the generator at the designated installation point.



WARNING! The generator can **ONLY** be raised and moved using the eyes provided on the generator. Do not put ropes or forks under the generator. Risk of damage!

4.5 STORAGE

If the generator will not be installed immediately but has to be warehoused for a prolonged period of time, the storage must take place in a sheltered environment, with a degree of protection appropriate for the installed components. It is especially necessary to:

- check that the surface on which the generator will be positioned is able to support it adequately and that it is completely level;
- always insert wooden platforms or other suitable platforms between the floor and the generator to prevent direct contact with the floor surface;
- cover the generator with a sheet of plastic in order to protect it from dust, humidity or other elements that could compromise its proper functioning;
- take the appropriate circulation and manoeuvring space to allow staff to carry out components harness and lifting operations of the generator comfortably and safely.

4.6 SHIPPING

Dispatch of the generator can be made choosing from these different solutions:

- a. Transport on wheels (truck).
- b. Air transport.
- c. Sea transport.
- d. Train transport.

Choose among the different means of transportation will be agreed between buyer and seller when they have stipulated the contract.



4.7 INSPECTION ON ARRIVAL

Upon delivery check that the packaging is intact and visually not damaged. If everything is intact, remove the packaging (unless otherwise instructed by VTE S.r.l. company). If you note damages or imperfections:

- Inform immediately the transport company and your agent, both by phone and written communication with return receipt;
- Acceptance of the material transported with reservation is to be carried out, since it is necessary to verify its integrity.
- Inform, for knowledge, the VTE S.r.l. company as mentioned above addressing your letter to:

VTE S.r.l.

Via Luciano Lama, 5
33059 Fiumicello – Villa Vicentina (UD) - Italy

Telephone: +39 0431 96488
E-Mail: info@volpitemco.com
Website: www.volpitemco.com

5. INSTALLATION OF THE GENERATOR

5.1 SET UP FOR INSTALLATION



Installation and commissioning of the generator must be carried out by a qualified technician or an authorized company.

It is the task of the installer to provide an area suitable for the overall dimensions of the generator and to carry out the necessary interventions for the correct and safe installation of the generator.



In the event of non-compliance with these indications, VTE S.r.l. will not be liable for any damage to the generator or any subsequent performance that does not meet the technical specifications provided.

1

5.2 FIXING THE GENERATOR

A solid, level mounting platform is very important for the proper operation of the generator. The support can be made of metal, wood, or fiberglass, and must meet the following conditions:

- is as low as possible, in order to minimize vibrations.

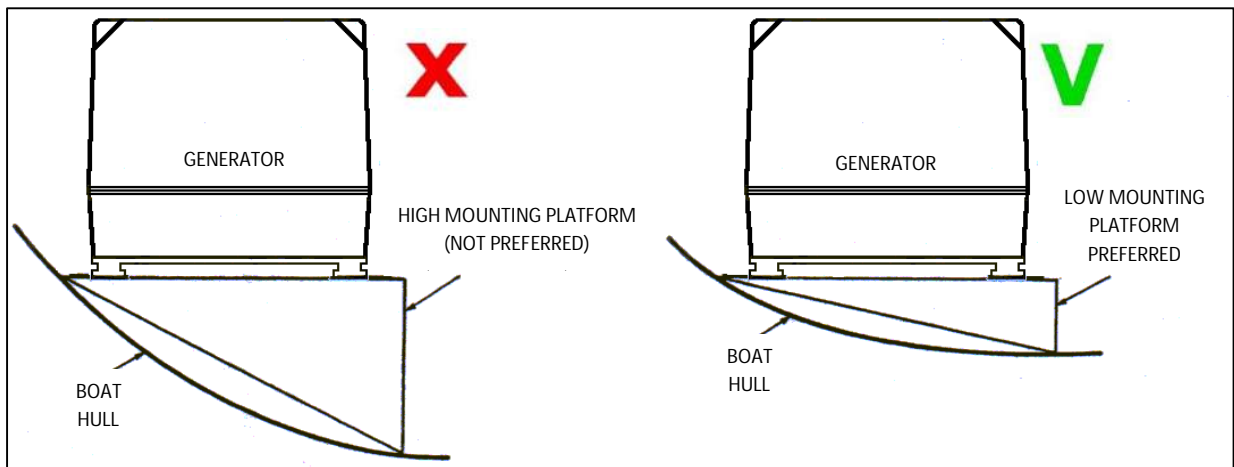

- keep the generator horizontal.

However, the following maximum inclinations are permitted if horizontal positioning is not possible due to lack of space on the boat:

- Longitudinal: 20°
- Transverse: 25°

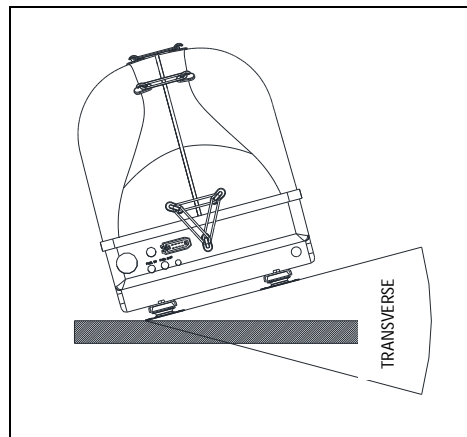
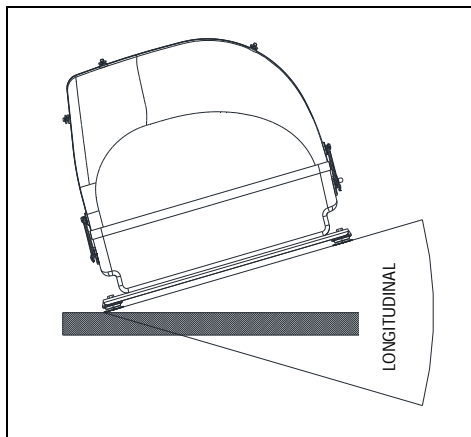

Locate the generator away from living quarters and away from bilge splashes and vapours.



Select a location that allows adequate space on all sides for ventilation and easy access for service. A further solution to increase the dampening of vibrations, is adding a plate between the generator and the boat's mounting platform. This will also improve the sound insulation. For this plate not less than 30 mm thick wood and soft mounts (see par. 2.5 "Vibration emission").

5.3 VENTILATION

Allow for the sufficient intake of cool air for proper engine combustion and the discharge of the heated air while the generator is running. Since heated air rises, the intake of cool air should be directed into the lower area of the generator compartment and the heated air should be discharged from the upper area of the compartment. The minimum distances to obtain correct ventilation of the generator are indicated in par. 2.2 "Minimum air change distance".

To ensure optimum air recirculation, it is also necessary to leave free the small ventilation holes provided on the bottom of the soundproofing capsule (lower protection) in order to allow the combustion air to pass from below.



Lower capsule – Internal side

5.4 EXTERNAL CONNECTIONS

The location of the external connections is shown in the images below. The various connections must be made with suitable diameters (as indicated in Chap. 1 "TECHNICAL SPECIFICATIONS") not only to avoid loosening or leakages, but also because using the correct sizes will prevent unnecessary gaps in the sound-shield that could emit noise.

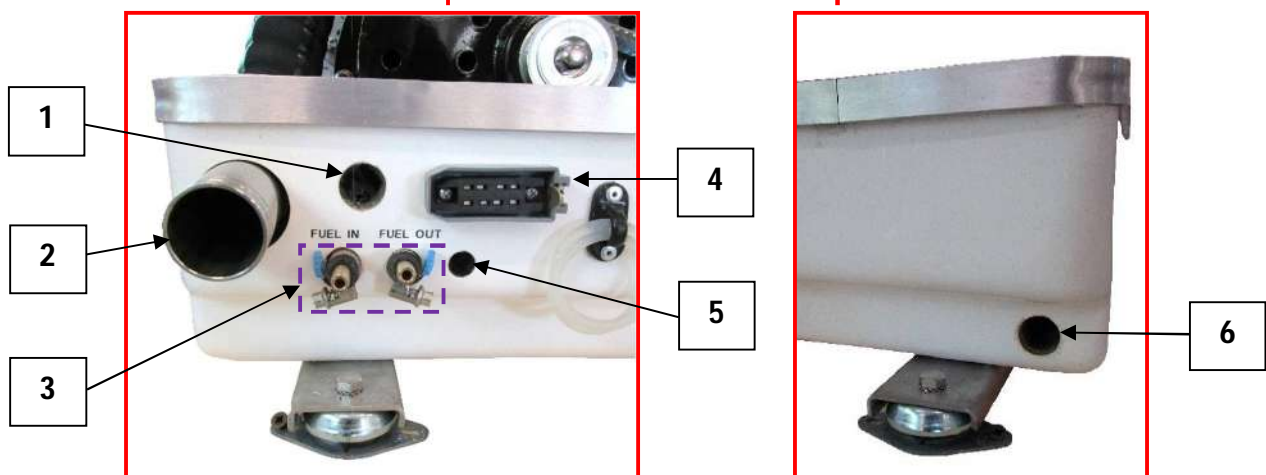
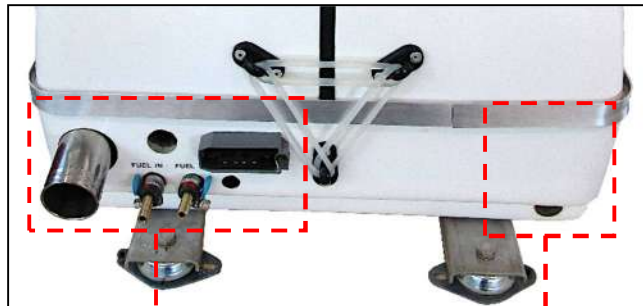

Paguro 3SY / 4SY / 5.5 SY connections (front side)



Paguro 3SY / 4SY / 5.5 SY connections (back side)

Key:

1. Passage of battery cables;
2. Gas/water mixer exhaust;
3. Diesel fuel supply and return (FUEL IN/OUT);
4. Remote control connector;
5. Passage cable of 230 V;
6. Cooling water flow;
7. Holes for the siphon-break.

5.5 EXHAUST SYSTEM INSTALLATION (on request)

The generator is supplied an exhaust manifold, on which an overtemperature safety switch is installed.

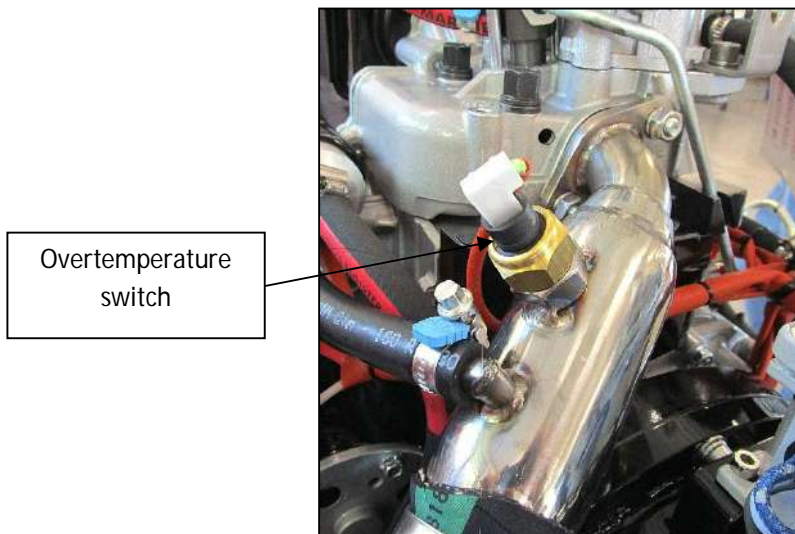

Exhaust manifold



It is the responsibility of the installer to design and install a suitable exhaust system in order to avoid water returning to the engine with any sea conditions and any inclination of the boat.

Connect the drain terminal with a water approved tubing and pass the drain system through the hole in the generator bottom capsule.

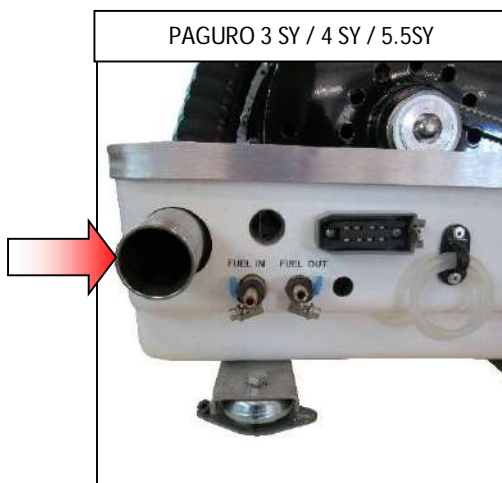

Holes for exhaust system piping passage



The installer **MUST** have a basic knowledge of the requirements of marine generator installations, safety systems and seawater cooling systems.

Incorrect installation and design of the exhaust line can cause severe damage to the generator, potentially causing the boat to sink.

The VTE S.r.l. warranty does not cover errors and inaccuracies in the installation of the exhaust line.

VTE S.r.l. recommends the installation of an exhaust system having in-line mufflers.

The in-line water-lock muffler must first muffler must be installed below the generator, in order to avoid water return/entrance into the engine. It must accumulate any water that runs back down the exhaust line after the engine is shut down. Design the system so there is an adequate drop in the line between the exhaust manifold and the thru-hull discharge end of the line. The exhaust hose must be certified for marine use.



WARNING! An exhaust line that is too long and/or has an incorrect slope can cause water to return to the engine when the generator is shut down.

The exhaust line connections must be secured in such a way as to avoid any dripping.

The exhaust gases are fatal. Install a carbon monoxide warning near the generator and in a clearly visible position.

5

5.5.1 Traditional system

The best noise dumping result is obtained fitting the 3 typical exhaust mufflers:

- the first, as **water-lock** avoids the risk of water return into the engine and reduces the acoustic emission by 50%;
- the second reduces a further 20% noise and must be fitted with a gradient towards the outlet in order to avoid water return;
- the third dumps a further 10% and avoids the risk of external seawater entrance due to waves.

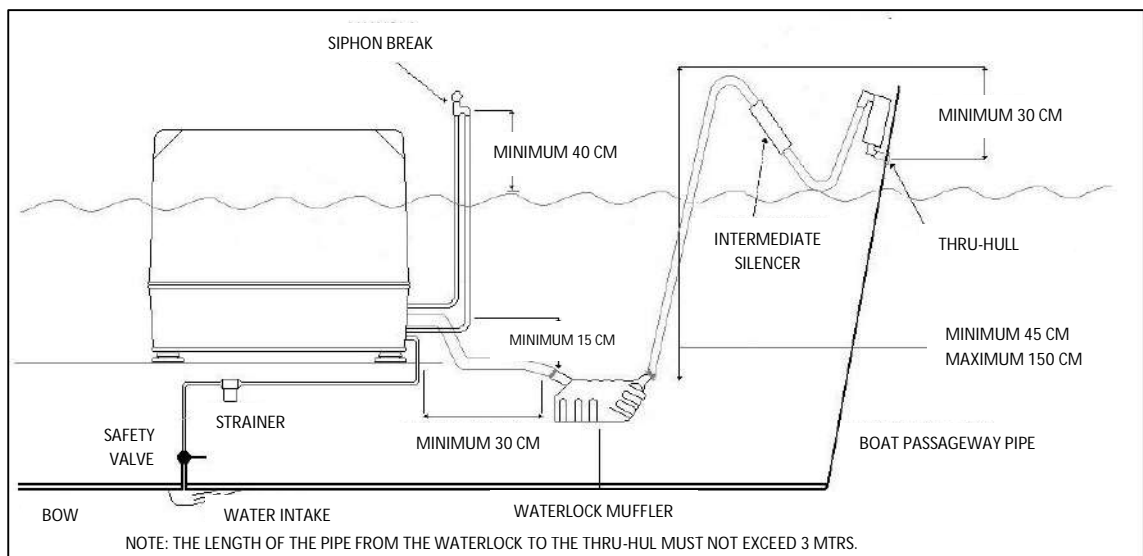

Traditional Plant diagram

Water exhaust separator: it is possible to reduce the noise of the exhaust line installing a water-exhaust separator as per the following image. In this case, the exhaust gas output is separated from the water output, so that the typical splash of the water (of the traditional exhaust lines) is eliminated.

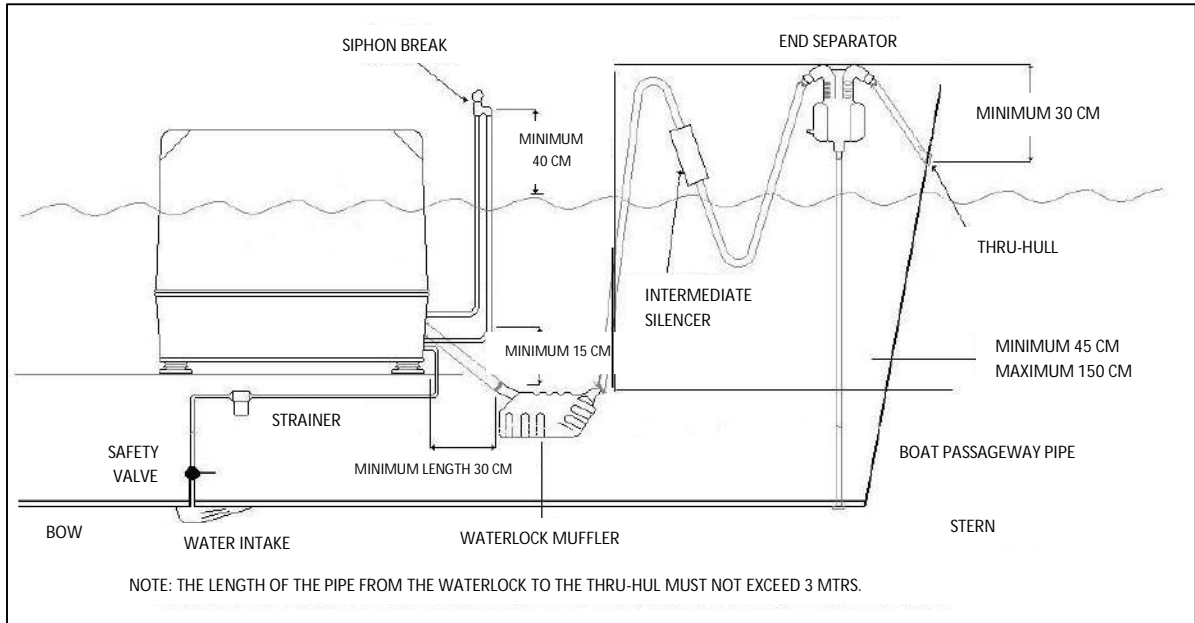

Traditional Plant diagram

In order to prevent water from returning to the engine, the water-lock muffler must be installed in a lower position than the generator, so that the exhaust pipe between the generator and the muffler has a downward slope. It is in fact necessary that there is a slope and the flow of water from the generator has a natural and forced downward path, so that when the generator is switched off, the cooling water present flows back toward the muffler.



The pipe from the generator to the water-lock muffler must be as short as possible (but not less than 30 cm) in order to reduce exhaust noise.

5.5.2 On-board system with space shortage

In case of lack of space for the installation of the mufflers, it can be installed the water-lock muffler only and, instead the other two mufflers, a loop with the exhaust pipe can be made. The lower side of the ring hold seawater, so that the noise emissions are reduced.

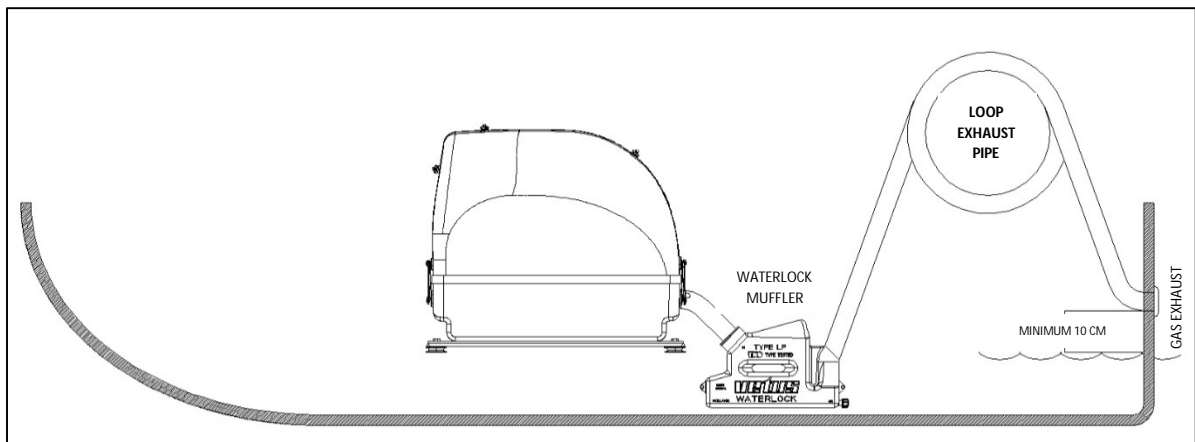

System diagram with lack of space

5.5.3 On-board system with long exhaust line

In case of a long exhaust pipe, it is recommended to use an exhaust system with two water-lock mufflers (see picture below). Due to the large quantity of water in the exhaust line, the second water-lock muffler protects the generator from water return.

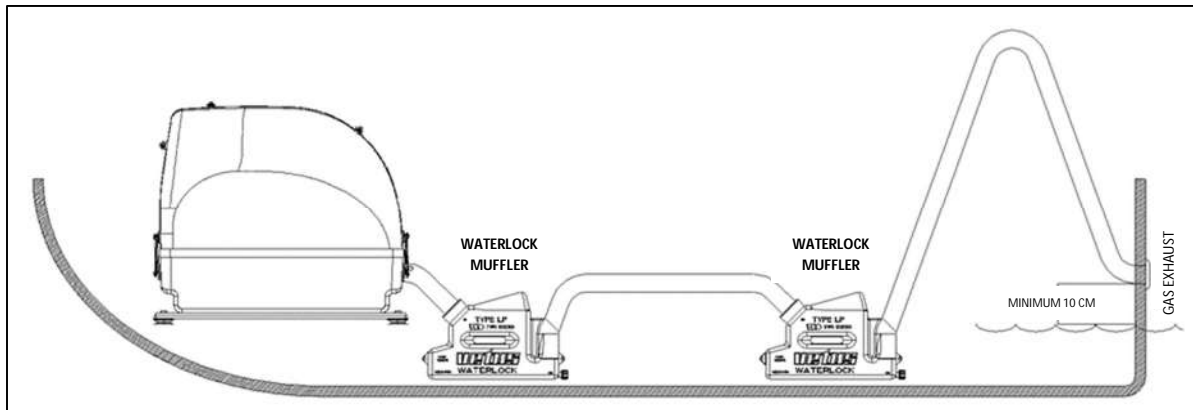

System with long exhaust line diagram

7

5.6 FUEL LINES

The generator is powered by diesel fuel via the two (FUEL IN - FUEL OUT) fuel supply pipes on the lower capsule.

DO NOT use other types of fuel.

FUEL SUPPLY LINE:

In most installations, the generator would use the same fuel tank as the vessel's propulsion engine. If this is the case, the fuel supply line to the generator should come from its own pick-up in the common fuel tank and not tee off the supply line to the propulsion engine. To assure proper suction, the generator's fuel pump should not be more than 1 m above the bottom of the fuel pick-up tube.

FUEL RETURN LINE:

The fuel return line must be connected to the top of the tank.

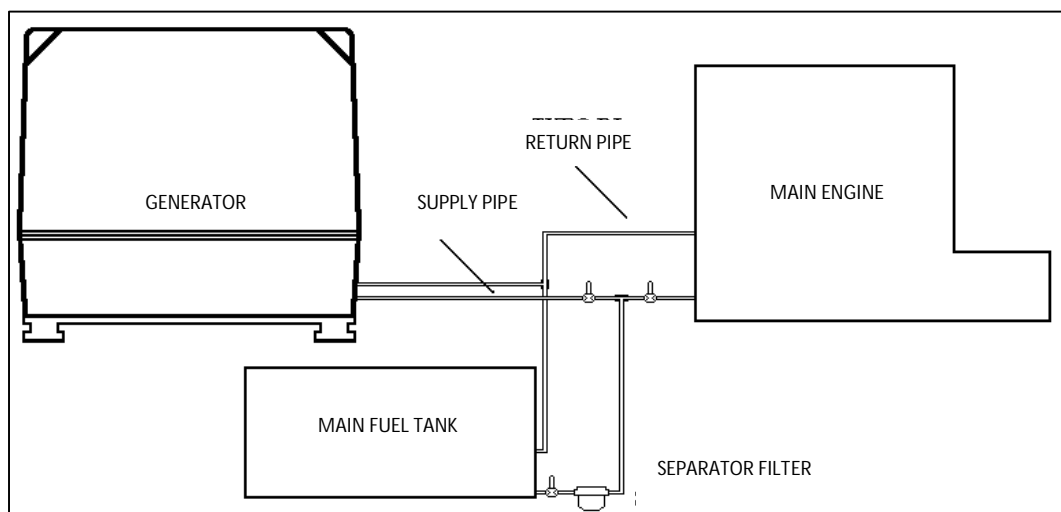

Supply system diagram

NOTE: The injection pump of the Paguro is a self-bleeding., it means that in case the engine shut-off for lack of fuel, after fuel tank filling up there is no need of disconnecting the pipes for bleeding, because this operation is simply obtained acting by hand on the lever of the feeding pump.

NOTE: Even if a fuel filter is contained in the capsule, it is necessary to install an external water/fuel separator.



Use only clean diesel fuel. The clearance of the components in your fuel injection pump is extremely critical; invisible dirt particles, which may pass through the filter, can damage these finely finished parts. It is important to only fill with clean diesel fuel and to keep it clean.



The best fuel can become unsatisfactory by careless handling or improper storage facilities. To make sure that your diesel fuel is clean and pure, purchase a well-known brand of fuel.



To assure that the fuel going to your engine is clean and pure, be sure to filter it properly. Use a good fuel/water separator having a filter element..

DIESEL SUPPLY AND RETURN DIAGRAM WITH GENERATOR LEVEL IN RELATION TO TANK ≤ 70 CM

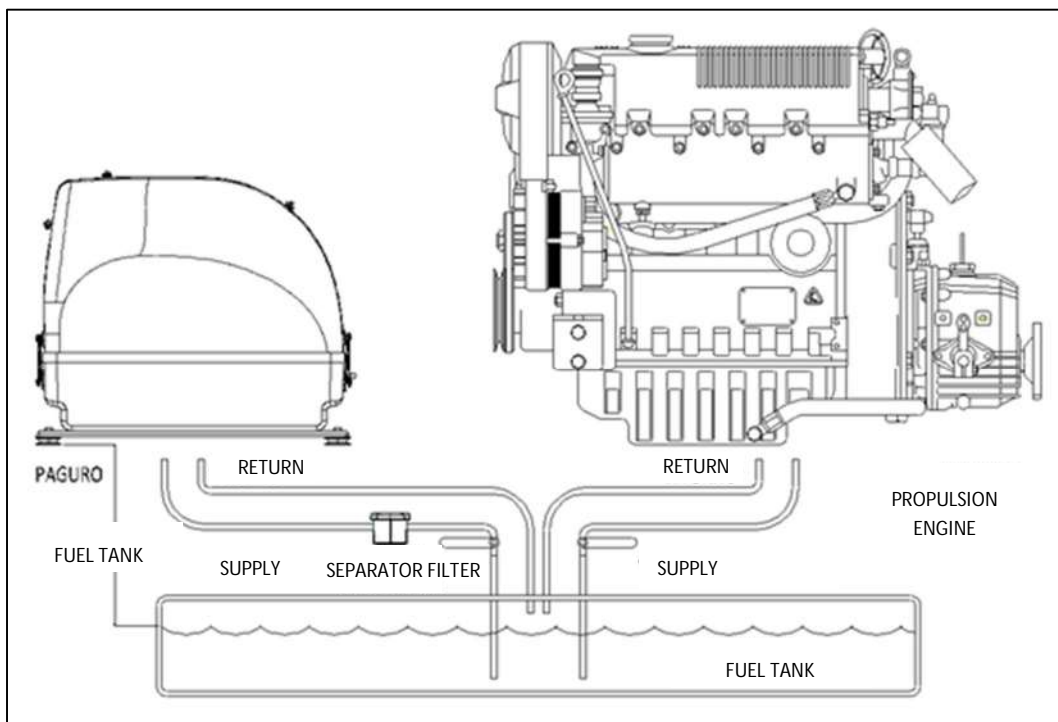

DIESEL SUPPLY AND RETURN DIAGRAM WITH GENERATOR LEVEL IN RELATION TO TANK ≥ 70 CM

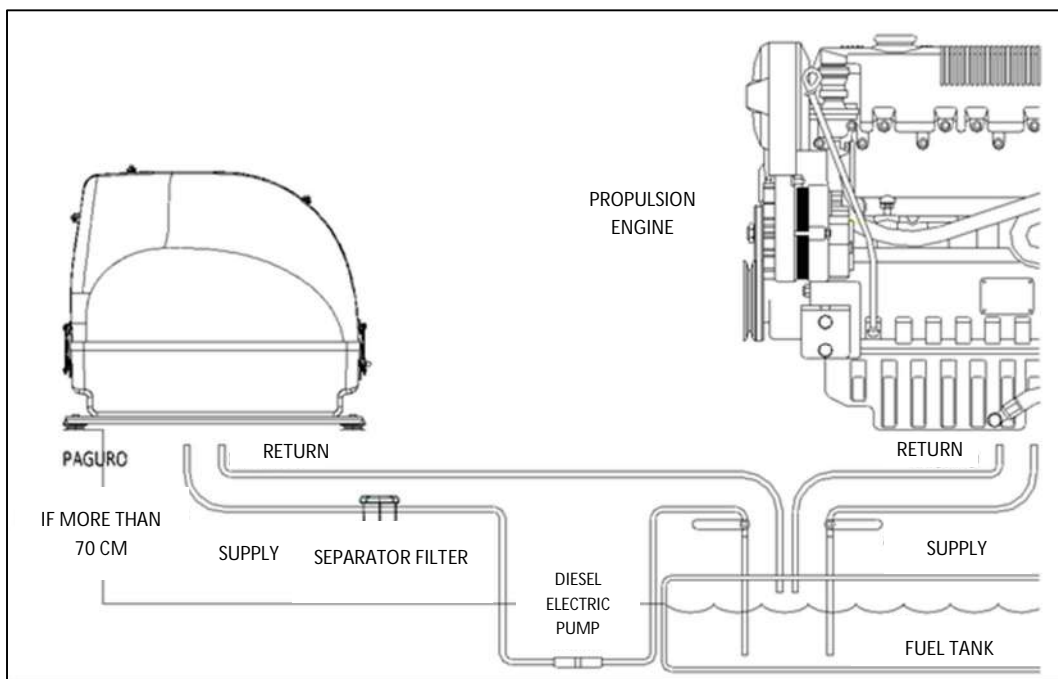

5.7 INSTALLATION OF THE COOLING SYSTEM

The raw water flow is created by a positive displacement impeller pump that is gear-driven by the camshaft. This pump draws cooling water directly from the raw water source (ocean, lake or river) through a hose. The raw water is pumped to the oil cooler in the sump. The water flows from the oil cooler to the alternator water-jacket, then to the engine heat exchanger. From the heat exchanger discharges into the water-injected exhaust manifold where it mixes with and cools the exhaust gasses. The installer provides for the connection of the tube, which adheres the sea water, to the pump by means of the attachment indicated in the figure below.

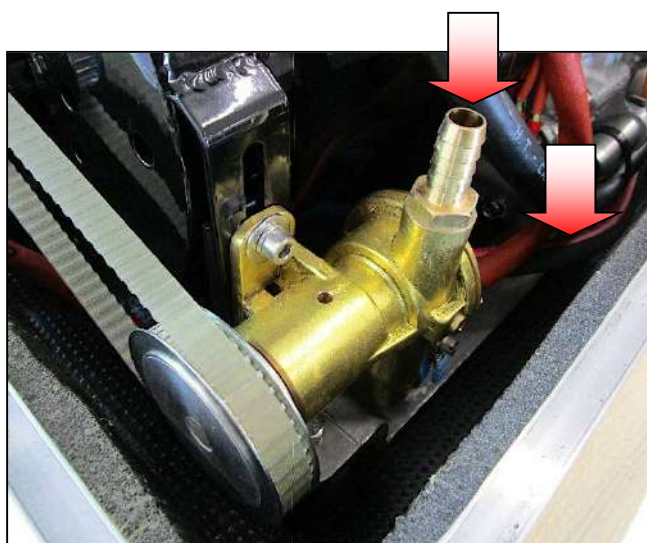

Sea water pump

5.7.1 Siphon-break valve

If the generator is installed below or at the same level of the seawater-line (refer to external shock absorbers), a siphon-break valve must be installed in the seawater cooling circuit.

The siphon-break valve prevents any seawater entrance into the engine through the seawater pump when the engine is installed below or at the same level of the seawater line, even considering the boat in movement.



Failure to use the siphon-break valve, when the external shock absorbers are located at or below the seawater line will result in raw water damage to the engine and possible flooding of the boat.

If in doubt, about the position of the external anti-vibration dampers, install a siphon-break.

10

The siphon-break must be installed in the high point of a hose that is looped a minimum of 50 cm above the vessel's waterline. This siphon-break must always be above the waterline during all angles of vessel operation to prevent siphoning from occurring. VTE has provided two siphon-break hoses (these are tagged). The hose (19 mm diameter) to the siphon-break connects to the raw water line at alternator water-jacket outlet. The hose (19 mm diameter) from the siphon-break attaches to the engine heat-exchanger inlet. If not ordered and included in the generator supply, the owner must furnish the siphon-break, and any additional lengths of hose that may be required.

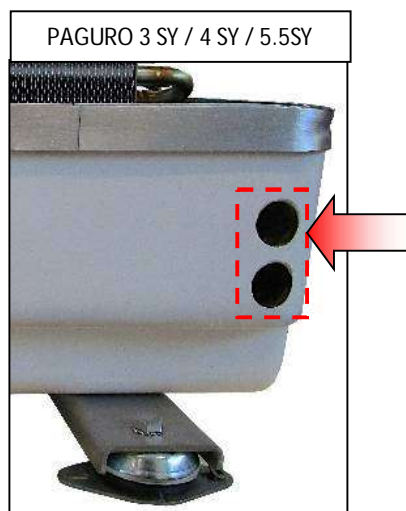

Holes for passage of anti-siphon valve supply and return lines



The siphon-break requires periodic inspections and cleaning to ensure proper operation. Failure to maintain the siphon-break properly can result in irreversible damage to the engine.



Consult the manufacturer of the siphon-break for proper scheduled maintenance.

5.7.2 Raw water intake (on request)

VTE S.r.l. recommends the “grid” type of raw water intake.

A flush-type thru-hull fitting is recommended for the raw water intake. It should be located on the boat's hull where it will be below the waterline during all angles of the boat's operation

NOTE: The seawater intake shape is usually designed asymmetrically, so that depending on the fitting direction can cause, when the boat is sailing, pressure or vacuum in the water circuit connected. For a generator the water intake must be fitted into the direction causing vacuum, because on the contrary a self-water entrance can be caused when the boat is sailing and the set is not running, flooding the exhaust line with water that finally reaches the engine oil sump causing severe damages to the engine

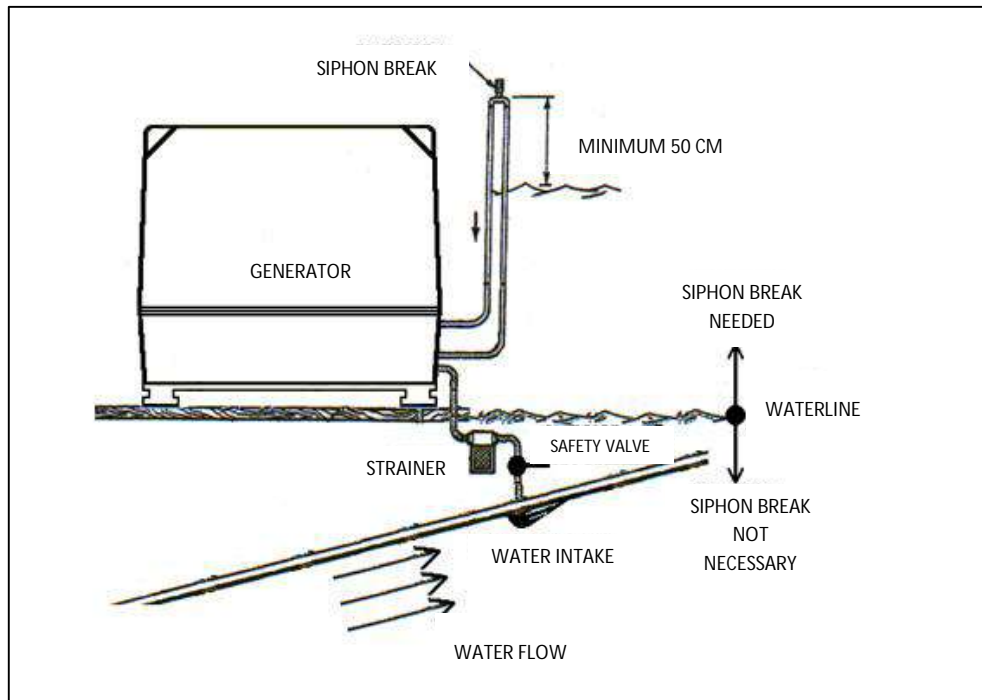

Sea inlet diagram



The generator can also be installed completely below the seawater line; in this case the siphon-break valve must be installed!

5.8 ELECTRICAL CONNECTION

5.8.1 Connection to starting battery

The PAGURO generator is negative grounded. For electric starting install a 12V battery of 90Amps. Connect the positive (+) battery cable to the starter solenoid where is already fitted a thin red cable and the negative (-) cable to the engine ground stud (one of the 2 studs located on the starter where is already foreseen a connector).

Please refer to the electrical drawing of this manual.

The generator's battery charger is designed to charge its starting battery only (8A max); In case of connection to the main board batteries the 8 Amps are available as well, but are not enough to charge them: an additional powerful battery charger fed by the main voltage generator must be installed on board.

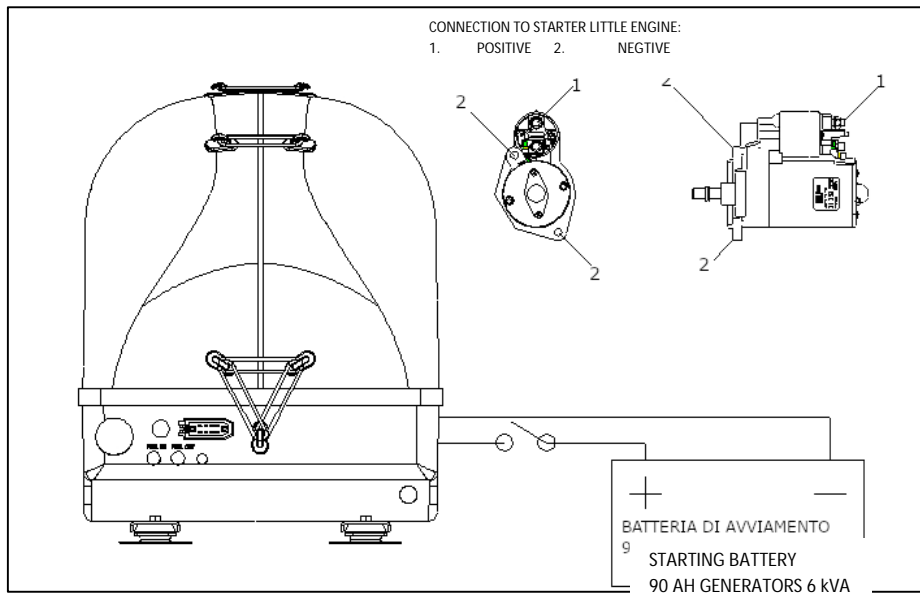

Startup battery diagram

5.8.2 Main output voltage

The connection of the main voltage (115V/230V AC) is located in electrical box (grey) installed above the alternator.

The following picture list the main components by model.

Please refer to electrical drawing.

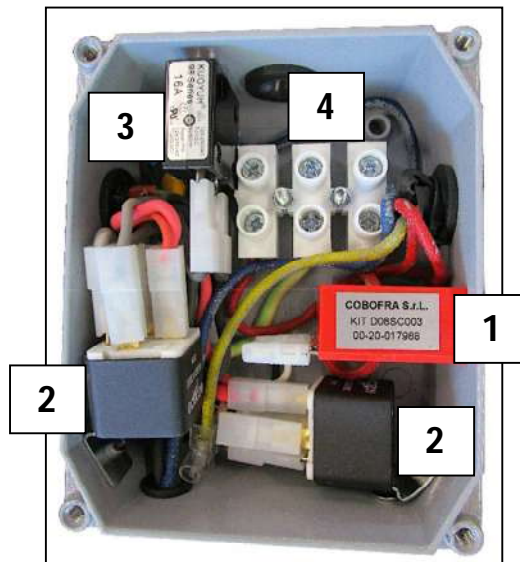

Scatola elettrica Paguro 3 SY / 4 SY / 5.5SY

Key:

- 1. Current transformer (TA);
- 2. Starting relay/preheating relay;
- 3. Thermoswitch;
- 4. Main voltage output.

5.8.3 Transfer switch over shore line / generator line

It must be absolutely avoided that the shore line and the generator remain contemporaneously connected to the boat plant.

A manual switch (shore / generator) or an automatic switch (shore / generator) must be provided.



Both the lines or at least the generator line only, have to be protected with a thermo-switch, fitted on the main board panel. For your PAGURO choose a:

	230V	115V
PAGURO 3SY	16A	32A
PAGURO 4SY	16A	32A
PAGURO 5.5SY	25A	40A

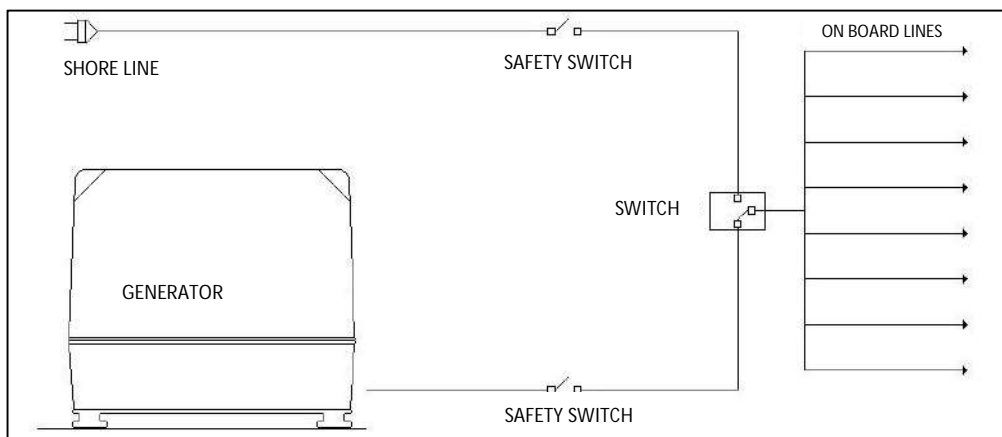

Electrical connections



When switching from the shore line to the generator (or vice versa), switch off the AC loads to avoid damages to the generator.

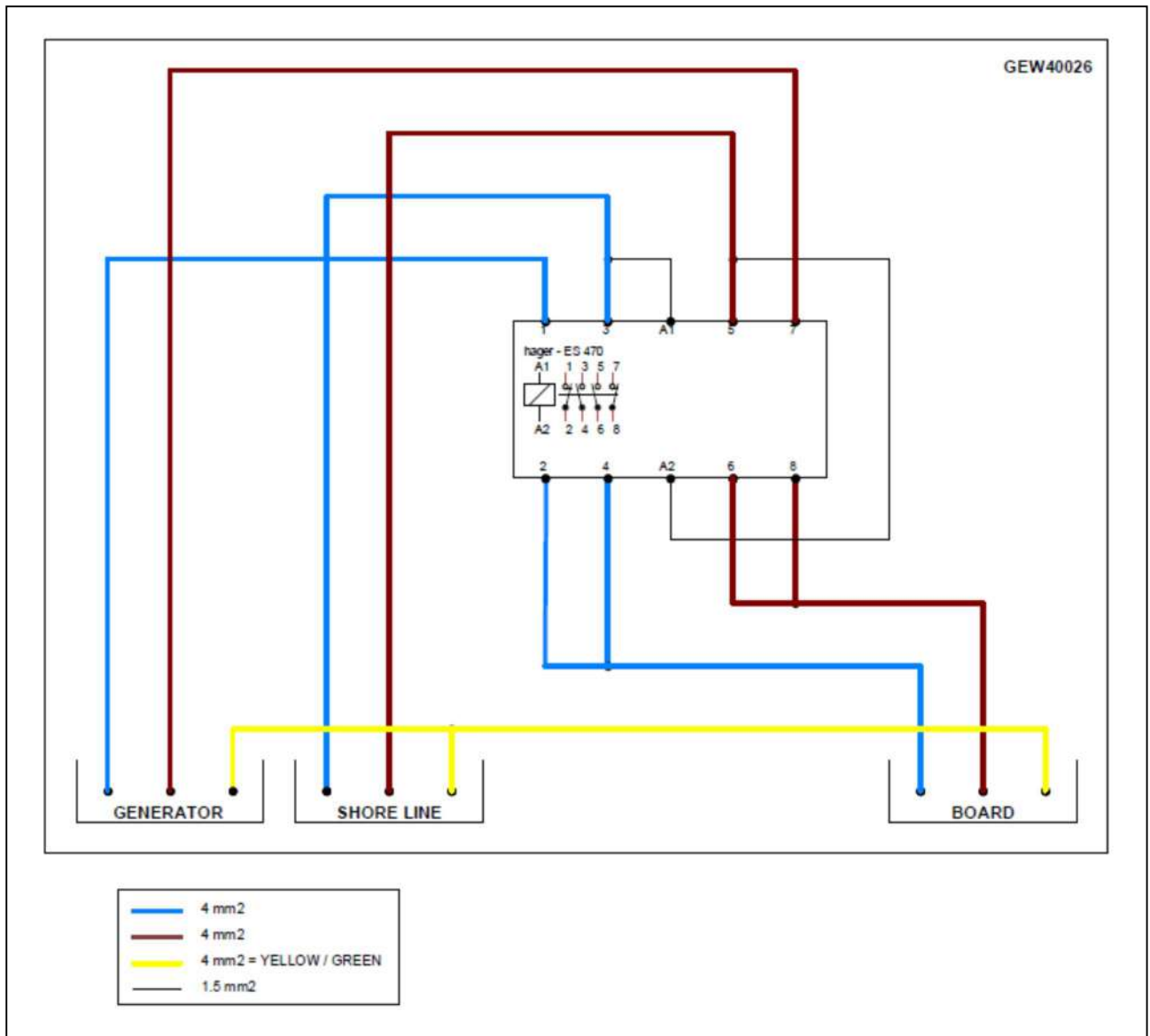

Automatic commutator (on request)

At the side of the electrical box, there is a safety switch that trips, interrupting the output of the battery charger section in case of overload.

In case of overload, fix the problem and then press the button to reset the protection.

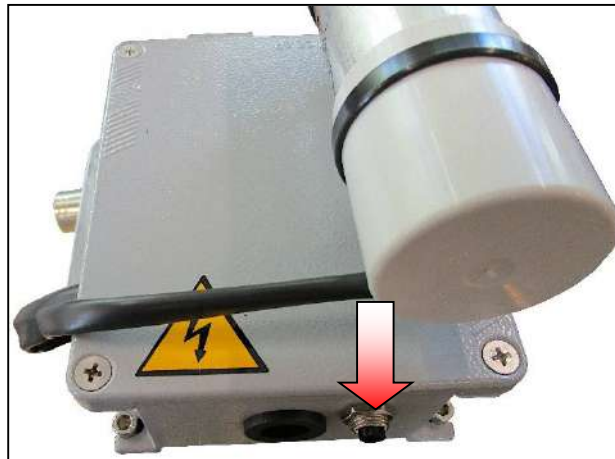

Paguro 3 SY / 4 SY / 5.5SY

5.8.4 Remote control panel

Install the plug-in control panel in any desired remote location always inside the vessel. The panel is supplied with 15 m of cable.

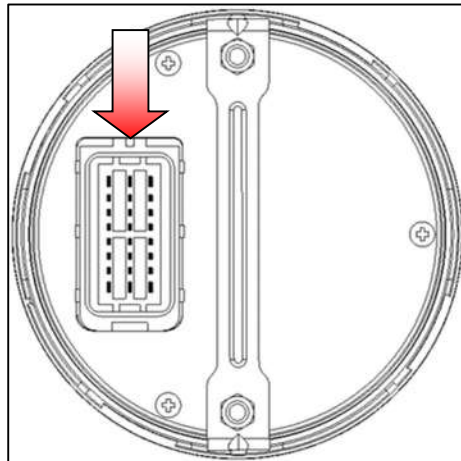

Control panel multipolar socket – Rear side

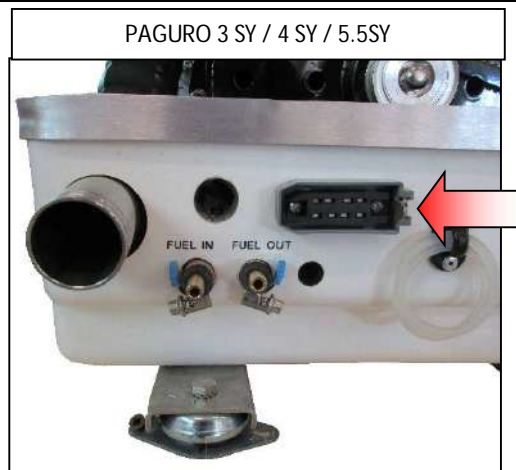

8-pole connector socket

For a description of the functions on the operator panel, refer to Chap. 8 “REMOTE CONTROL PANEL”.

5.9 PRE-START INSPECTIONS

Before starting your engine for the first time, or after a prolonged layoff, check the following items:

- Check that the generator has not been damaged during transport and installation.
- Check the engine oil level. Add oil to maintain the level according the indication on the dipstick.
- Turn on the fuel supply, then check the fuel supply and examine the fuel filter / water separator bowl for contaminants.

NOTE: refer to the specifications for the proper diesel fuel and lubricating oil types and quantities.

- Check the DC electrical system. Inspect wire connections and battery cable connections. Make certain the positive (+) battery cable is connected to the starter solenoid and the negative (-) cable is connected to the engine ground stud.
- The shore power safety switch must be OFF.
- The shore power transfer switch must be in the GENERATOR mode.
- Open the raw water intake.
- Visually examine the generator. Look for loose or missing parts, disconnected wires, and unattached hoses. Check the threaded connections. Check for fuel leaks.
- Make sure the exhaust system is secure and all the connections are tight.
- Make sure there is a good ventilation and an ample air supply. These are necessary for proper engine performance.
- Make sure the mounting installation is secure.
- Check load leads for correct connections as specified in the wiring diagrams.
- Be sure no other generators or utility power is connected to the load lines.
- Check the integrity of the pictograms and signals on the generator.
- Check the integrity of the remote control panel with particular care.

5.10 TESTING

The test was carried out at the company **VTE S.r.l.**, where all the mechanical calibrations and the size measurements were carried out.

6. INSTALLATION ERRORS

A big number of marine generators of any type and manufacturers, after the first installation on board, are flooded by sea water causing severe damages to the engine with consequent high repairing costs, improperly claimed in warranty but gently refused, because it always depends from a critical/wrong installation, made compromising some physical rules.

The following paragraphs list the most common errors that can occur and that must be avoided.

6.1 WATER INTAKE

- Seawater intake oriented towards sailing direction, causing a dynamical pressure that, when the generator is not running, let flow sea water through the cooling pump, reaching the exhaust pipe and consequently the engine exhaust valve, flooding the cylinder and the oil sump.
- On a high-speed motorboat, a neutral flush hull mounted water intake can cause as well dynamical pressure due to the hull gradient compared the sea surface, or the decreased water line level before reaching the proper trim.

NOTE: To avoid the risk, the water intake entrance must be fitted facing the rear position and even so, in critical sailing conditions the internal valve must be closed when the generating set is not in operation.

6.2 WATERLINE

- Installation below the seawater level without a proper cooling pipe goose neck and siphon-break valve.
- If the generator installation surface is just a little below the external sea water level, foresee an external goose neck pipe with siphon break valve, on the contrary drop by drop an internal leakage through the pump clearance, fills the exhaust pipe with the same above explained result. For relevant level difference the leakage occurs when the boat is not sailing too.

NOTE: The valve must be positioned outside the generator in the highest position possible, but in any case, at least 50 cm above the waterline and must be connected, by interposing it to any pipe of the cooling circuit, in the delivery zone of the pump, suitably extending the relative pipes. The soundproofing capsule must be drilled in the most suitable position to allow the pipes to come out. For each model of Paguro generator the optimal position may be different, but any piping in the pressure zone is suitable for the purpose.

6.3 EXHAUST LINE

- An exhaust line trapping too much water for length excess or negative gradient course, that return back into the engine when the generator is shut off.
- The first water lock muffler is designed for avoiding that risk, but if fitted not enough lower than the engine manifold either reversing the entrance with the outlet, or of too reduced capacity for the return water volume that has to contain, can be unable avoiding the problem.
- Care must be taken in designing the exhaust pipe course, preferring the alternatives that keep self-draining towards outside as more pipe stroke as possible.
- In any case, to be sure of a correct and safety installation, especially during the first employment season, check often the lubrication oil integrity watching the engine steak level: a transparent yellow oil if new or a black colour if old, mean no water entrance, but an emulsion similar to milk white/yellow not transparent or worst an increased level into the sump mean water flooding.

- Another water presence signal becomes from starting difficulties as due to some roost on the exhaust valve, the compression does not reach the proper burning value. Spraying some lubricating oil into the cylinder while insisting with the starter, very often the engine can be started. When started the valve self-cleans, but in some cases, of too long-time water presence, also the piston rings are locked from roost, so the engine must be opened for repairing.
- In some cases, the engine does not start for external reasons like lack of fuel, air bubbles, too flat battery. While insisting, the water pump deliver a certain quantity of water, that is not pushed out by the engine exhaust pressure, remaining trapped into the exhaust pipe even if correctly fitted. If that happens, drain the exhaust pipe when giving up the unsuccessful starting operation.
- When the installation is correctly planned and carried on, surveying the result during the first operative season, the generator on board give many troubles operative seasons, requiring lubricating oil and fuel filter replacement only, but there is another up keeping operation that prolong considerably the unit life. It consists in a "wintering" but useful in summer too if the set remains unemployed for more than two months
- However, there are definable operations of "wintering" useful even when the machine remains inactive for several months which prolong its operating life and the maintenance of performances over time. Due to temperature difference between night and day the water remaining into the exhaust pipe and muffler water lock causes condensation, that on the engine exhaust valve, produces roost.
- Spraying into the combustion chamber some lubricating oil, and disconnecting the exhaust pipe, moving the piston position by the handle or a flash starting attempt, avoids completely the roost risk for long time.
- Consider that on the marine engines employed for the nautical generating sets, there are no critical connections between cooling water and fire zone, so in case of some gasket breakage there is water sprayed out of the engine, around it into the hood and never water entering into the piston or the sump zone.



IMPORTANT! VTE S.r.l. is in any case at customer's disposal for additional suggestions or solving out of standard cases for getting the complete satisfaction result, that can be always reached putting more attention on the plant.

7. STARTING/SOPPING PROCEDURE

7.1 CHECKS TO BE CARRIED OUT BEFORE STARTING

Before starting, the following checks must be carried out:

1. Check for possible leaks from all the connections inside the sound-shield.
2. Make sure the cooling water is discharging properly, outboard from the exhaust outlet.
3. Make certain that the generator is mounted securely.
4. Listen for unusual sounds and vibrations.

Once these checks have been carried out and the correct operation has been verified, the upper guards of the capsule can be closed, making sure to make the 2 halves fit together correctly and to lock them in place using the appropriate silicone rubber bands.

1

7.2 START-UP PROCEDURE

Button to start the generator.

Press and hold the button for approximately 10 seconds. This time is required to start the pre-heat and then the generator. Release the button only when the generator starts.



Control panel



WARNING! All AC loads must be switched off before starting. This precaution will prevent damage caused by unanticipated operation of AC machinery and will prevent a cold engine from stalling.

NOTE

If a start attempt is aborted, reset the circuit by pressing the “STOP” button.

Apply a light load to the generator and allow the engine to warm up to operating temperature before applying heavy loads.



WARNING! Prolonged cranking intervals without the engine starting can result in the engine exhaust system filling with raw water. This may happen because the pump is pumping raw water through the raw water-cooling system during cranking. This raw water can enter the engine's cylinder once the exhaust system fills. Prevent this from happening by closing the raw supply through-hull shutoff, draining the exhaust muffler, and correcting the cause of the excessive engine cranking. Remember that engine damage resulting from raw water entry is not covered by VTE S.r.l.'s warranty.



WARNING! Never operate the engine for long periods of time without an amperage load being applied, otherwise carbon build-up may occur which can cause severe damage to the engine.

2

7.3 OPERATING THE GENERATOR

After the generator has started, run it with a medium load for warm up. If possible, apply the load in stages. Operate the generator no more than 70% of the load for the first 50 hours.



WARNING! Do not attempt to break-in your generator by running without a load.

After the first 10 hours of the generator's operation, the load can be increased to the full-load rated output; then periodically vary the load.

Always avoid overload. An overload is signaled by the red LIGHT lighting located on the remote control panel, by a smoky exhaust with reduced output voltage and frequency. Monitor the current being drawn from the generator and keep it within the generator's rating.

To protect against unintentional overloading of the generator, the generator's output leads should be routed through a circuit breaker that is rated at the rated output of the generator.

7.3.1 Check list

Follow the following check-list every day before starting the generator:

- Record the hour-meter reading in your log (engine hours relate to the maintenance schedule).
- Visually inspect the engine for fuel, oil or water leaks.
- Check the oil level (dipstick).
- Check your diesel fuel supply.
- Check the starting batteries (weekly).
- Check for abnormal noise such a knocking, vibration and blow by sounds.
- Confirm exhaust smoke:
 - When the engine is cold - White Smoke.
 - When the engine is warm - almost Smokeless
 - When the engine is overloaded - some Black Smoke
- Make sure the cooling water is discharging properly, outboard from the exhaust outlet.



After the first 20 hours of generator operation, check the maintenance table (par. 10.3.7) for the correct maintenance operations to be carried out.

7.4 STOPPING THE GENERATOR

To stop the generator, follow this procedure:

1. Remove the AC loads from the generator one at a time and allow the generator to run for an additional 3 to 5 minutes (this stabilizes its operating temperature).
2. Press the "STOP" button on the remote control panel to stop the generator. The shutdown is automatic;
3. Check the lube oil level a few minutes after stopping the engine, because lube oil from the bearings etc. continues to drain down into the oil sump. Disregarding this fact and not maintaining the proper oil level may lead to overfilling, causing overheating and the possibility of engine runaway.
4. After shutdown, carefully inspect the generator. Check for possible leaks from all the connections inside the sound-shield.

3



Control panel

8. REMOTE CONTROL PANEL

8.1 CONTROL PANEL DESCRIPTION

The generator is supplied with the remote control panel and 15 m of cable with multipolar sockets at the ends for connection to the generator.

The operator panel is a device that allows you to start, stop and manage generator functions. Each function is described below.

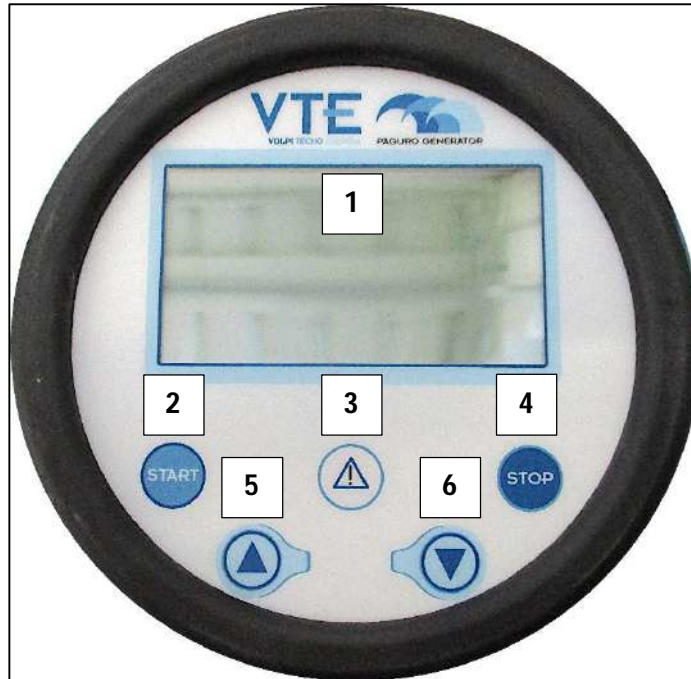

Remote control panel

1. LCD DISPLAY

LCD display with white backlight. As soon as the operating panel is electrically powered, the display will show the manufacturer's logo "VTE" and then the screen below will appear.

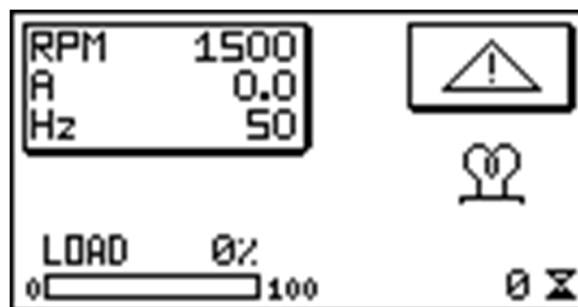

The parameters displayed on the display are described as follows:

- Engine speed: RPM
- Supplied current: A
- Frequency: (Hz)
- Hour counter: hourglass icon
- Load indicator: %

An icon will also appear on the display to help you quickly identify any alarm generated by the generator. An intermittent warning light indicates the generator is being preheated.

2. **START**

Button to start the generator.

Press and hold the button for approximately 10 seconds. This time is required to start the pre-heat and then the generator. Release the button only when the generator starts.

3. **ALARMS ICON**

Red LED indicator. The indicator illuminates when an alarm is generated.

4. **STOP**

Button to stop the generator.

Press the button once and release.

5. **UP ARROW**

Button to move the cursor up in the display menu.

Keep the button pressed to obtain the "ESC" function.

6. **DOWN ARROW**

Button to move the cursor down in the display menu.

Keep the button pressed to obtain the "SEND" function.

8.2 ALARM MANAGEMENT

The operator panel checks several parameters to detect any faults on the generator and, if necessary, stop the generator to prevent serious damage.

Alarms generated:

- Over temperature / low oil pressure:
If an over temperature or low oil pressure situation occurs, the generator will shut down. The red LED light will illuminate and the alarm will appear on the display.
The temperature sensors are present:
 - N.1 near the exchanger.
 - N.1 on the exhaust terminal.
- Electrical overload:
In case of electrical overload, the generator will not stop. The red LED light will illuminate and the alarm will appear on the display.

8.2.1 Reset alarms

To reset the alarm, proceed as follows:

1. Clear the alarm icon from the LCD by pressing the UP or DOWN ARROW button.
2. Turn off the red LED by pressing and holding the UP or DOWN ARROW button for 5 seconds.

8.3 ELECTRICAL CONNECTIONS (8 WIRES BLUE CABLE / CONTROL PANEL)

The table below shows the electrical connections between the generator, the 8-wire cable and the control panel.

Connector 8 PINS	15 m cable	Connector 24 PINS	Description
1A	red	8A and 4C	Battery positive
2A	brown	1A	Fuel lock valve
3A	grey	3C	Engine start
4A	green	3B	Sensors (temp. / press.)
1B	black	8C	Battery negative
2B	yellow	1B	Pre-heating
3B	white	5A	Load indicator
4B	blue	7C	Generator running
-	-	3A	Automatic start (on request)

8.4 AUTOMATIC STARTING DEVICE (on request)

The remote control panel can be supplied with a normally open (NO) contact.

When the contact is closed the generator starts, when the contact is opened the generator stops. Contacts available on the 24-pin connector between pin 3A and pin 8C.

9. GENERAL SAFETY INFORMATION

Read these safety instructions carefully. Most accidents are caused by failure to follow fundamental rules and precautions. Know when dangerous conditions exist and take the necessary precautions to protect yourself, your personnel and your machinery.

The following safety instructions are in compliance with the American Boat and Yacht Council (ABYC) standards.

9.1 PREVENT ELECTRIC SHOCK

- **Do not touch AC electrical connections while engine is running, or when connected to shore power. Lethal voltage is present at these connections!**
- Do not operate this machinery without electrical enclosures and covers in place.
- Shut-off electrical power before accessing electrical equipment.
- Use insulated mats whenever working on electrical equipment.
- Make sure your clothing and skin are dry, not damp (particularly shoes) when handling electrical equipment.
- Remove wristwatch and all jewelry when working on electrical equipment.
- Do not connect utility shore power to vessel's AC circuits, except through a ship-to-shore double throw transfer switch. Damage to vessel's AC generator may result if this procedure is not followed.
- Electrical shock results from handling a charged capacitor. Discharge capacitor by shorting terminals together with an insulated tool.

9.2 PREVENT FIRE

- **Do not touch hot engine parts or exhaust system components. A running engine gets very hot!**
- **Steam can cause injury or death!**
- In case of an engine overheat, allow the engine to cool before touching the engine or checking the coolant.
- Prevent flash fires. Do not smoke or permit flames or sparks to occur near the fuel line, filter, fuel pump, or other potential sources of spilled fuel or fuel vapors. Use a suitable container to catch all fuel when removing the fuel line or fuel filters.
- Keep the compartment and the engine / generator clean and free of debris to minimize the chances of fire. Wipe up all spilled fuel and engine oil.
- Be aware – diesel fuel will burn.

9.3 PREVENT EXPLOSIONS

- **Explosion from fuel vapours can cause injury or death!**
- Follow re-fueling safety instructions. Keep the vessel's hatches closed when fueling. Open and ventilate cabin after fueling. Check below for fumes / vapor before running the blower. Run the blower for four minutes before starting your engine.
- All fuel vapors are highly explosive. Use extreme care when handling and storing fuels. Store fuel in a well-ventilated area away from spark-producing equipment and out of the reach of children.
- Do not fill the fuel tank(s) while the engine is running.
- Shut off the fuel service valve at the engine when servicing the fuel system. Take care in catching any fuel that might spill. DO NOT allow any smoking, open flames, or other sources of fire near the fuel system or engine when servicing. Ensure proper ventilation exists when servicing the fuel system.
- Do not alter or modify the fuel system.
- Be sure all fuel supplies have a positive shutoff valve.
- Be certain fuel line fittings are adequately tightened and free of leaks.
- Make sure a fire extinguisher is installed nearby and is properly maintained. Be familiar with its proper use. Extinguishers rated ABC by the NFPA are appropriate for all applications encountered in this environment.

9.4 ACCIDENTAL STARTING

- **Accidental starting can cause injury or death!**
- Disconnect the battery cables before servicing the engine/generator. Remove the negative lead first and reconnect it last.
- Make certain all personnel are clear of the engine before starting.
- Make certain all covers, guards, and hatches are re-installed before starting the engine.

9.5 BATTERY EXPLOSION

- **Battery explosion can cause injury or death!**
- Do not smoke or allow an open flame near the battery being serviced. Lead acid batteries emit hydrogen, a highly explosive gas, which can be ignited by electrical arcing or by lit tobacco products. Shut off all electrical equipment in the vicinity to prevent electrical arcing during servicing.
- Never connect the negative (-) battery cable to the positive (+) connection terminal of the starter solenoid. Do not test the battery condition by shorting the terminals together. Sparks could ignite battery gases or fuel vapors. Ventilate any compartment containing batteries to prevent accumulation of explosive gases. To avoid sparks, do not disturb the battery charger connections while the battery is being charged.
- Avoid contacting the terminals with tools, etc., to prevent burns or sparks that could cause an explosion. Remove wristwatch, rings, and any other jewelry before handling the battery.
- Always turn the battery charger off before disconnecting the battery connections. Remove the negative lead first and reconnect it last when servicing the battery.

9.6 BATTERY ACID

- **Sulfuric acid in batteries can cause severe injury or death!**
- When servicing the battery or checking the electrolyte level, wear rubber gloves, a rubber apron, and eye protection. Batteries contain sulfuric acid which is destructive. If it comes in contact with your skin, wash it off at once with water. Acid may splash on the skin or into the eyes inadvertently when removing electrolyte caps.

9.7 HIGH NOISE

- **A high level of noise can cause damage to your hearing!**
- Do not operate the machine with the silencers disconnected.
- Do not keep the machine running for a long time without the soundproofing capsule closed.



WARNING! Do not operate the machine when you are mentally or physically unempowered by fatigue.

It is also strictly forbidden to:

- ⊘ Tampering or by-passing safety devices;
- ⊘ Use of inappropriate tools/equipment;
- ⊘ Modify command and control devices;

10. MAINTENANCE

The term "MAINTENANCE" includes the following fields of activity:

1. **Inspection:** includes measures designed to recognize the actual condition, i.e. to identify the reasons and ways in which the wear reserve is reduced.
2. **Restoration:** includes measures designed to achieve the desired condition, i.e. to compensate for the reduction in performance and to restore the wear reserve.

The personnel authorized to install and carry out the generator maintenance must be well trained and must have a thorough knowledge of safety regulations.



Unauthorized personnel must remain distant of work area during maintenance operations.

Safety precautions must be always strictly respected during the installation and generator maintenance, in order to avoid any injury to personnel and any damage to machinery.

10.1 CUTTING OF THE ENERGY SOURCES



The ordinary or extraordinary maintainers workers are required to work on the generator to perform maintenance, lubrication, and repairs only when the generator is not enabled and/or under voltage.

Before performing any maintenance, cleaning, and repair work it is necessary to put the generator in safety mode, so:

- disconnect the generator from the electric supply.
- wait for parts subject to extreme temperatures to cool.



WARNING! FAILURE TO FOLLOW THESE PRECAUTIONS CAN LEAD TO SERIOUS DAMAGE TO PEOPLE, THE GENERATOR AND PROPERTY. IN MORE SEVERE CASES, IT CAN CAUSE DEATH (ELECTRIC SHOCK, FUEL-RELATED FIRE, ETC.).

The safety condition is achieved by implementing the "MAINTENANCE STATE" procedure, described in paragraph 10.3 "Ordinary maintenance".

Before starting the maintenance:

1. Display the "**MAINTENANCE IN PROGRESS**" sign on the generator.

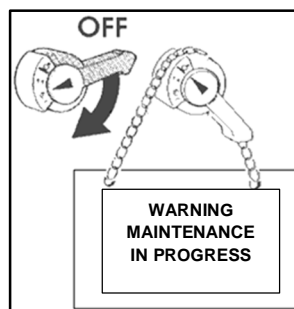

2. Access to the generator is allowed **only to authorized personnel**.
3. Do not modify or tamper with the generator structure without a written statement to the company **VTE S.r.l.**
4. Record the maintenance operations on the "SHEET OF MAINTENANCE INTERVENTIONS" attached to the manual, which shows the date, group of the generator, type of work and signature of the person who performed the operation. Keep the updated table close to the generator.

Any maintenance operation should refer to what is written in this chapter.

10.2 ORDINARY MAINTENANCE

10.2.1 Maintenance status

MAINTENANCE STATUS AND maintenance operations are the exclusive responsibility of the maintainers, each for their skills, as defined in the Cap. 3 "OPERATOR":

The procedure provides **for insulation from electrical energy**:

- press the "STOP" key on the remote control to stop the generator.
- the service technician disconnects the battery cables using suitable Personal Protective Equipment and electrically insulated tools.

Before servicing the generator, use protective gloves and always wait until all components of the generator are at room temperature (< 50°C).



The maintainer, once the maintenance work has been completed and before returning the generator to operation, must always check that:

- **any parts replaced and/or tools used have been removed from the generator.**
- **check that all the guards removed during the operation are refitted, correctly positioned and secure with their elastic bands.**

Only at the end of the maintenance intervention and after having made the appropriate checks can the operating conditions be restored.

10.2.2 General safety warnings

Generator and also operator safety depend on the regularly scheduled maintenance procedures, in accordance with the Manufacturer instructions. Maintenance workers must:

- observe the limits of their qualifications (mechanical or electrical);
- in accordance with their own competencies, follow the User and Maintenance Manual procedures and the warnings associated with it;
- respect the indicated times and frequency of scheduled maintenance procedures.



GENERAL WARNINGS applicable to any situation:

- risk of electrocution by direct contact with power supply terminal boards and junction boxes in the electrical system;
- it is prohibited to open terminal boards and junction boxes when the generator is running;

Carefully inspect the generator before starting it again and check that all guards are correctly refitted and secure.

10.2.3 Functional checks on safety devices

The primary task of the ordinary maintenance technician is to check the efficiency of the safety devices after every maintenance operation and before putting the generator back into operation:

- generator guards, which prevent the contact of dangerous parts through the human body;
- magnetothermal circuit breaker, which acts to protect the generator in case of overload;
- in general, of all safety devices present on the system.



The installer and maintenance technician must not modify or circumvent the safety devices with which the generator is equipped.

10.2.4 Maintenance of the electrical system

Definition of tasks and competences of the personnel.

Maintenance of the electrical parts and the general electrical system of the generator must always be entrusted to operators (installers and maintainers), in accordance with their competencies, as defined in the following paragraphs.

The Manufacturer declines all responsibility if these instructions are not followed.

Skills of the generator installation operator:

The installer is only authorized to perform mechanical and plant installation of the generator.

Skills of the ordinary maintenance electrician technician:

The electrician in charge of ordinary maintenance is the operator in charge of ordinary maintenance of the electrical system. This person must have technical skills in the field, specialized experience, knowledge of the generator and of the User and Maintenance Manual.

The ordinary maintenance technician is authorised:

- restore the operating conditions prevented by the intervention of electrical protective devices (e.g. thermal-magnetic circuit breakers tripped);
- make minor repairs to the system within the limitations and in accordance with the instructions in the User and Maintenance Manual;
- replace failed signalling devices;
- change broken parts.



WARNING!

– Broken parts must be replaced with original parts (or with equivalent parts, with written authorization from the generator Manufacturer).

Replacement must be carried out in accordance with the original connections and functionality.

– The parts that require calibration (such as magnetothermal switches, etc.) must be calibrated with the same values as the original part that was replaced.

The ordinary maintenance technician is FORBIDDEN to:

- change the electrical connections in the generator system.
- modify the generator wiring.

IMPORTANT! Repairs and procedures that require modifications to the system are the exclusive responsibility of the Manufacturer or authorised service centres.

10.2.5 General advices

To carry out the maintenance operations safely:

- respect the timescale for scheduled maintenance as stated in the User and Maintenance Manual (preventive and periodic);
- the distance (indicated by time or by work cycles) between one procedure and another is to be understood as the maximum acceptable; therefore, it shouldn't be exceeded; it can however be abbreviated;
- good preventive maintenance requires constant attention and continuous supervision of the generator.

Promptly check the cause of any abnormalities such as excessive noise, overheating, fluid leakage, etc. and fix them. In case of doubt, contact the Manufacturer or the authorised service centre. Always refer to the attached documents such as manuals for installed equipment for maintenance.

10.2.6 Maintenance plan

From a construction point of view, these interventions concern the mechanical and electrical parts.

From an operational point of view, for the maintenance technician these operations can be divided into two categories:

- planned, scheduled maintenance (or preventive).
- scheduled maintenance according to the condition.

The planned, scheduled maintenance (periodic or preventive) involves inspections, checks and other operations to prevent downtime and breakdowns, and keep under systematic control:

- the mechanical conditions of the generator and particularly of the drives.
- the state of lubrication of the generator.

Ordinary maintenance according to condition concerns components or generator parts for which it is not possible to predetermine wear or intervention times. These components must be kept under control and replaced when they are too worn out to be suitable for use.

10.2.7 Ordinary maintenance table

To keep the generator running smoothly it is necessary to observe the maintenance schedule provided by the Manufacturer. Failure to comply with the above will release the Manufacturer from any responsibility for the effects of the warranty.

IMPORTANT! The timeframes refer to normal operating conditions, i.e. compliant with the envisioned conditions for use established by contract.

Refer to the relevant manual for maintenance of the endothermic engine (see attachments).

OPERATIONS TO BE CARRIED OUT AFTER THE FIRST 50 HOURS OF OPERATION AND WEEKLY

- Check that there are no leaks;
- Check the operation of the siphon-break;
- Check that the connections are secure;
- Check the exhaust manifold for clogging or corrosion. If necessary, clean it;
- Replace the engine oil filter.

OPERATIONS TO BE CARRIED OUT AFTER THE FIRST 50 HOURS OF OPERATION AND EVERY 100 HOURS

- Check that the connections and the electric cables are secure;
- Control the condition of the sea inlet filter. If necessary, clean it;

OPERATIONS TO BE CARRIED OUT DAILY OR EVERY 10 HOURS

- Check the engine oil level. If the level does not exceed the minimum level, top up;
- Check the coolant level. If the level is below the mark, it must be topped up;
- Check the integrity of the fuel system and that there are no drips.
- Check that there is no water or dirt in the fuel. If not, replace the fuel/water separator filter;
- Check that there are no leaks;
- Check the exhaust system for leaks around the terminal, seals and welds;
- Check the integrity of the exhaust system insulation. Replace if damaged.

OPERATIONS TO BE CARRIED OUT WEEKLY

- Check the condition of the batteries and ensure that the connections are secure;
- Clean any corrosion on the batteries;
- Perform a thorough cleaning of the generator. A dirty, oil-filled surface prevents the generator from cooling.

OPERATIONS TO BE PERFORMED EVERY 250 HOURS

- Squeeze the cooling system hoses to assess wear. Replace them if worn;
- Replace the oil filter with the original one. Dispose of it in the designated collection centres;
- Replace the fuel filter with the original and bleed the fuel system. Dispose of the filter in the designated collection centres.
- Replace the excitation capacitors with original ones. Dispose of it in the designated collection centres;
- Check the starter solenoid for corrosion. If necessary, lubricate.
- Check the plug of the zinc anode for worn. If necessary, replace with the original.
- Verify the worn of the sea water pump impeller. If necessary, replace with the original.

IMPORTANT! It is recommended to always carry a spare kit consisting of impeller and impeller seal.



Impeller and seal

OPERATIONS TO BE CARRIED OUT EVERY 300 HOURS

- Replace the engine oil by pulling it out with the oil pump.

OPERATIONS TO BE CARRIED OUT EVERY 500 HOURS

- Clean the heat exchanger tube nest.
- Adjust the rocker arm clearance at a Service Centre authorized by the Manufacturer **VTE S.r.l.**

OPERATIONS TO BE CARRIED OUT EVERY 1000 HOURS

- Perform calibration and cleaning of injectors at a Service Centre authorized by the Manufacturer **VTE S.r.l.**

OPERATIONS TO BE CARRIED OUT EVERY 2500 HOURS

- Perform partial overhaul of the generator at a Service Centre authorized by the Manufacturer **VTE S.r.l.**

OPERATIONS TO BE CARRIED OUT EVERY 5000 HOURS

- Perform general overhaul of the generator at a Service Centre authorized by the Manufacturer **VTE S.r.l.**

10.3 EXTRAORDINARY MAINTENANCE

Extraordinary maintenance operations concern breakages of parts and components where specific knowledge of the fault is required.

In this case contact the Manufacturer.



WARNING! All the interventions of extraordinary maintenance must be performed only with the generator not working and in safety conditions (generator in "maintenance state"). The operations of extraordinary maintenance must be performed by personnel authorized and trained by the manufacturer.

Competences of the technical electrician, extraordinary maintenance technician.

The extraordinary maintenance electrician is a technician employed by the Manufacturer or by his authorized service centres.

He is the operator responsible for the extraordinary maintenance of the electrical system. This individual must have a technical training and qualification, a specialized experience, a knowledge of the generator and of the User and Maintenance Manual.

Furthermore he/she must be continuously updated, through specific training courses at the headquarter of the Manufacturer and must have the knowledge and the required documentation to safely carry out complicated procedures on the systems.

The extraordinary maintenance technician is authorised to:

- intervene on parts of the system that are critical to safety;
- make any changes to the connections and wiring on the generator;
- replace devices and components with others that may be different to the originals;
- make changes to the software of the generator;
- change the parameters set on the electronic devices.

The extraordinary maintenance technician shall document any modifications and/or replacements in writing and shall provide a copy of the documentation to the ordinary maintenance technician and a copy to the Manufacturer.

The ordinary maintenance technician must update every copy of the User and Maintenance Manual in the customer's possession; the changes must be highlighted and marked in writing on every copy of the User and Maintenance Manual of the modified generator (directly on the original pages and inserting, if necessary new update sheets).

10.4 TROUBLESHOOTING

This paragraph lists, in a table, the most common inconveniences that can arise, possible causes and the most suitable solutions to fix them.



WARNING! WHEN THE DESCRIBED SOLUTIONS ARE NOT ENOUGH TO SOLVE THE PROBLEM, THE USER MUST NOT PROCEED OF HIS/HER OWN INITIATIVE BUT MUST CONTACT THE MANUFACTURER FOR FURTHER INFORMATION.

Read the "ORDINARY MAINTENANCE" chapter very carefully before carrying out any maintenance procedure.







Two symbols are provided in the table below, identifying the OPERATOR and MANUFACTURER respectively:



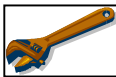











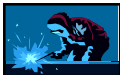















: an operation that can be carried out by the operator.



: contact the Manufacturer for detailed information.

	PROBLEM	POSSIBLE CAUSES		SOLUTION
1	The engine does not start.	Lack of power supply.		Check the electric system (batteries, electric connections, devices).
		Temperature inside engine compartment too high.		Wait for the generator to cool down and restart the generator. If the problem persists, contact Technical assistance.
		No fuel.		Fill.
		Thermal intervention.		Reactivate.
		Low battery;		Recharge or replace.
2	The generator does not energize.	Engine speed reduced.		Check the revolutions and bring them to the nominal value.

		Faulty capacitor.		Replace.
		Demagnetized fields.		Apply a high load.
		Faulty windings.		Check the resistance of the windings.
3	The engine starts and stops.	Clogged air filter;		Replace.
		Fuel pump defective.		Replace.
		Clogged fuel filter;		Replace.
4	High no load voltage (over 240 V).	Engine speed too high.		Check the revolutions and adjust.
		High value capacitor.		Check and replace.
5	Low no load voltage (over 230 V).	Engine speed too low.		Check the revolutions and adjust.
		Rotating diodes faulty.		Check and replace.
		Damaged windings.		Check the resistance of the windings.
		Low value capacitor.		Check and replace with a higher value.
6	Normal voltage at no load but low at load.	Engine speed reduced at load for fuel filter clogged.		Replace.
		Load too high.		Reduce loads.
		Rotating diodes faulty.		Check and replace.
7	Unstable voltage.	Loose contacts.		Check the connections.

		Clogged fuel filter;		Replace.
8	Low engine oil pressure.	Oil pump worn.		Replace.
		Adjustment valve not registered.		Record.
9	Noisy generator	Damaged bearings.		Replace.
		Loose coupling.		Check and repair.
10	Fluid leaks found.	Loose lines or fittings.		Position and tighten properly.
		Faulty lines or fittings.		Replace. Contact Technical Support.
11	High cooling water temperature.	Thermostat defective		Replace.
		Dirty tube nest.		Clean.
		Worn seawater pump impeller.		Replace.
		Blocked lines.		Check and release.
12	The generator makes an unusual noise.	Mechanical parts or components of the generator may be loose or faulty.		If the problem persists, contact Technical assistance.
		Exhaust system fault.		Shut down the generator immediately, inspect the system, and contact Technical Support if necessary.
13	Excessive vibration.	Mechanical parts or components of the generator may be loose or faulty.		If the problem persists, contact Technical assistance.

10.5 MAINTENANCE PROCEDURES

The following paragraph provides specific procedures for servicing the generator. Maintenance operations must be carried out with the generator in maintenance state by authorized technical personnel.



WARNING! Replaced oils and specific elements (filters, etc.) must be disposed of in accordance with the regulations in force. NEVER disperse in the environment.



WARNING! During the operations, the maintainers must wear Personal Protective Equipment, gloves, accident-prevention shoes, overalls or other devices eventually needed by the law in force, according to the type of the operations to do.

10.5.1 Replacing the sea water pump impeller

The raw water pump is a self-priming, rotary pump with a non-ferrous housing and a neoprene impeller. The impeller has flexible vanes which wipe against a curved cam plate within the impeller housing, producing the pumping action. On no account should this pump be run dry as water acts as a lubricant for the impeller. There should always be a spare impeller and impeller cover gasket (an impeller kit) onboard. Raw water pump impeller failures occur when lubricant (raw water) is not present during engine operation. Such failures are not warrantable, and operators are cautioned to make sure raw water flow is present at start-up. The neoprene impeller has a limited lifetime and must be inspected regularly.

If the impeller is damaged, replace it using the following procedure:

1. Close the raw water intake valve;
2. Remove the fixing screws and the pump cover;
3. Pull out the damaged impeller;

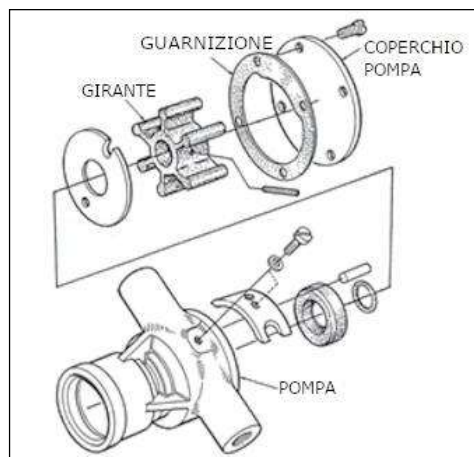

Impeller

4. Position the new impeller close to the pump body;
5. Move the blades to form the housing and push the impeller as far as it will go.

NOTE: Add some lubricant to the impeller and seal during assembly.

6. When the operation is complete, reopen the sea water inlet valve.

10.5.2 Cleaning the raw water intake filter

The raw water intake filter is one of the fundamental components of the generator cooling system. Check the condition of the filter frequently. The internal water must be clear and clean and there must be no impurities on the retina.

To clean the filter properly and safely, follow these steps:

1. Close the sea water intake valve;
2. Remove and clean the filter;
3. Clean the transparent cover of the filter;
4. Assemble the filter;
5. Open the sea water intake valve;
6. Start the generator and check for drips.

NOTE: Cleaning of the filter is also necessary after a generator shutdown due to overtemperature, as algae, leaves and other material may obstruct the regular passage of the cooling water flow.

10.5.3 Checking engine oil

Check the lube oil level daily, prior to starting. With continuous operation, check the oil level every 8-10 hours. Check the lube oil level a few minutes after stopping the engine because lube oil from the bearings etc. continues to drain down into the oil sump. Disregarding this fact and not maintaining the proper oil level may lead to overfilling, overheating and engine runaway.

If a top-up is necessary, clean the area around the oil filler to prevent dirt from entering the engine.

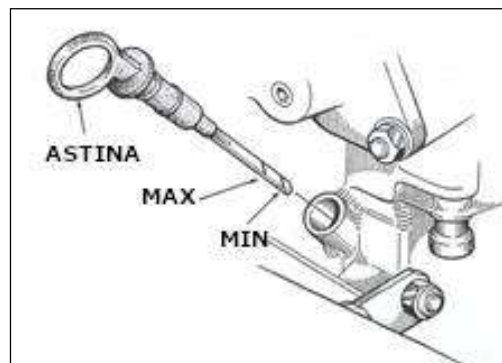

Check oil level

10.5.4 Adding engine oil

Add the new oil through the top-up point on the engine (yellow cap). After refilling with new oil, run the engine for a few moments. Make sure there is no leakage around the manual oil pump, then stop the engine. Then check the quantity of oil with the lube oil dipstick. Fill to, but not over the full mark on the dipstick, should the engine require additional oil.

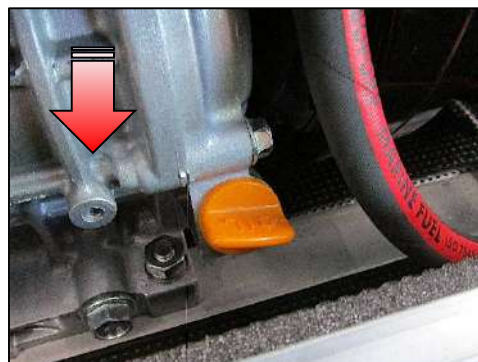

Engine oil filling

10.5.5 Replace the engine oil

Replace the engine oil by following these steps:

1. Start the engine and bring it to operating temperature;
2. Stop the engine;
3. Remove the dipstick 1 to allow the engine oil to drain more easily;
4. Place a container under the engine to collect the used oil;
5. Remove the replacement cap located in the lower part of the cylindrical block 2, allowing the oil to be replaced;
6. After all the oil has been replaced, insert the replacement cap 2 and tighten it to 19.6-23.5 N * m (2.0-2.4 kgf * m);
7. Dispose of used oil appropriately.

12

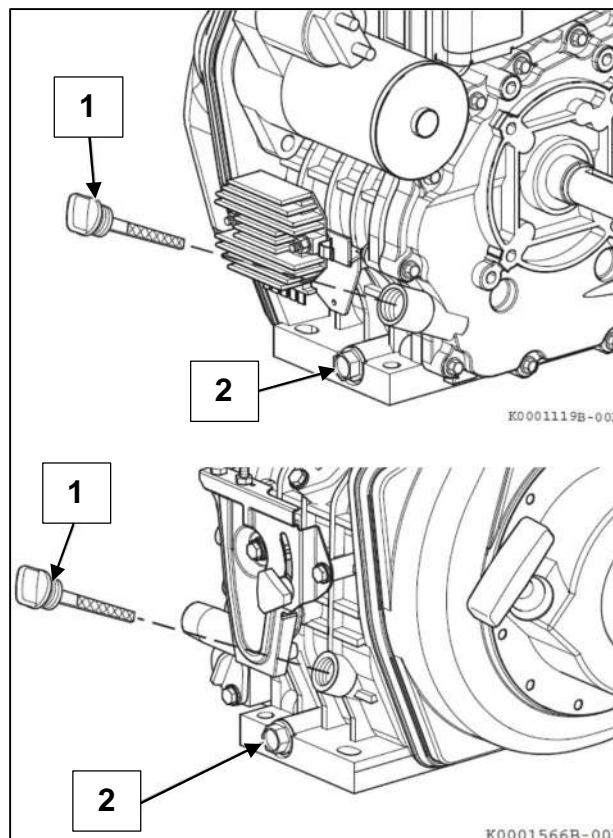

Replace the engine oil;

10.5.6 Checking and cleaning of the engine oil filter

Clean and check the engine oil filter according to the following procedure (see figure on the next page):

1. Remove the oil filter retaining bolt 1;
2. Pull out the oil filter cap 2 and remove the oil filter 3;
3. Clean the oil filter and replace it if damaged;
4. Install the oil filter 3;
5. Make sure that the oil filter cap 2 is well positioned;
6. Insert and tighten the retaining bolt 1;
7. Add new engine oil (as specified in 10.5.4);
8. Warm up the engine by turning it on for 5 minutes and check for any oil leaks;
9. After the engine has been warmed up, stop it and do not restart it for 10 minutes;
10. Check the oil level again by fully inserting the dipstick without screwing it;

11. Add the oil in step 4 until the level is between the upper 6 and lower 5 notch of the dipstick;
12. Reposition the rod 1 and tighten it manually. Pay attention that overtightening causes damage to it. If oil has been spilled, dry it with a clean cloth.

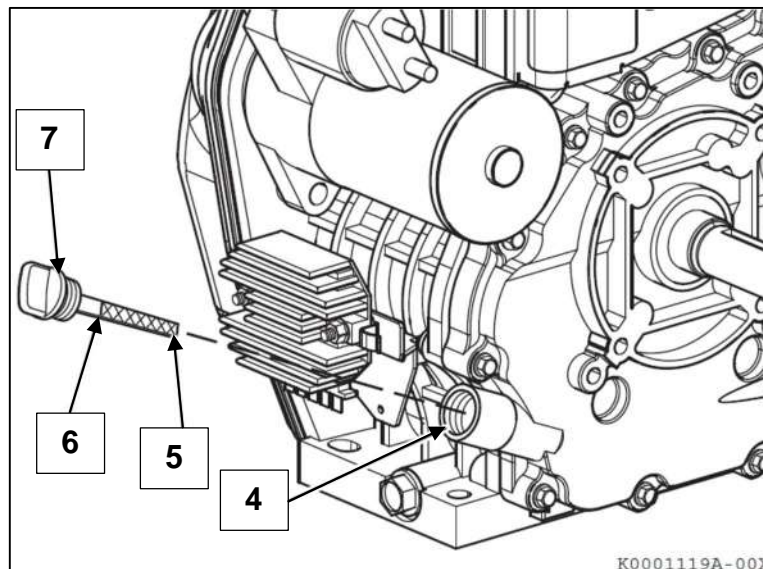
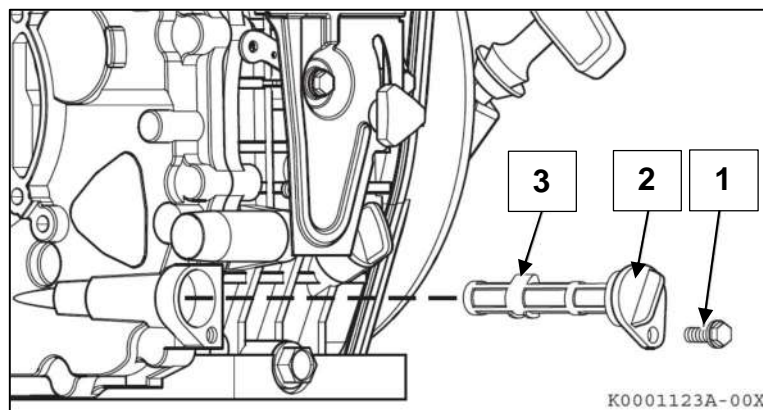

Checking and cleaning of the engine oil filter

10.5.7 Cleaning of the fuel filter in entrance

To clean the fuel inlet filter correctly and safely, proceed as follows (see figure on the next page):

1. Clean the area surrounding the fuel cap 1;
2. Remove the fuel cap 1 from the fuel tank 3;
3. Remove the fuel filter inlet 2;
4. Clean the inlet fuel filter or replace it if damaged;
5. Install the fuel filter inlet 2;
6. Replace the fuel cap 1 and hand tighten it. Pay attention that overtightening will damage it.

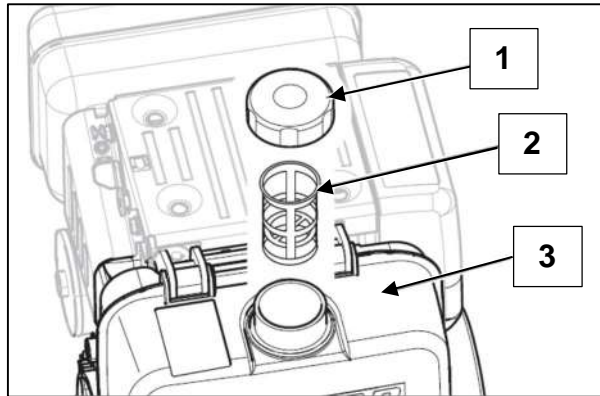

Cleaning of the fuel filter in entrance

10.5.8 Cleaning of the air filter

To clean the air purification element correctly and safely, follow these steps:

1. Remove the wing nut 1;
2. Remove the cover of the air purifier 2;
3. Remove the wing nut 3;
4. Remove the air purification element 4 and the external foam element 5;
5. Blow the air through both elements using compressed air at 0.29-0.49 Mpa (3.0-5.0 kgf / cm²) to remove particles. Use low air pressure if possible to remove dust without damaging the elements;
6. If each item is damaged, replace both (they are not sold individually);
7. Clean the inside of the cover of the air purifier 2;
8. Install the air purification element 4 in its special container and carefully check that the air filter cartridge is correctly inserted and aligned with its housing;
9. Install the wing nut 3 and hand tighten it. Pay attention that excessive tightening causes damage to the assembly of the purifier;
10. Slide the external foam element 5 over the air purification element 4;
11. Install the cover of the air purifier 2;
12. Install the wing nut 1 manually. Pay attention that excessive tightening will damage the assembly of the purifier

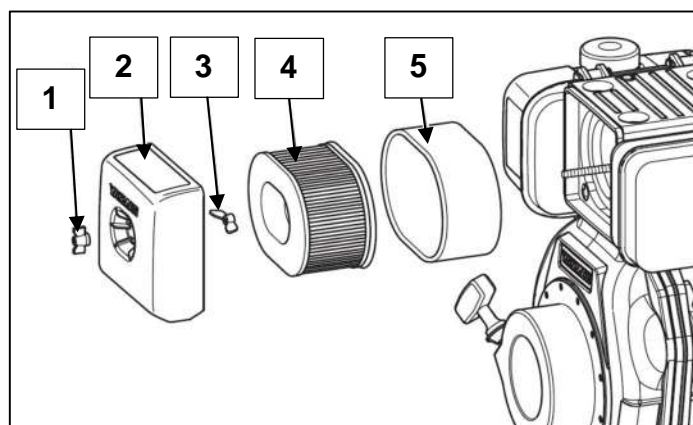

Cleaning of the air filter

10.5.9 Emptying the tank and replacing the outlet filter

Empty the fuel tank and replace the outgoing fuel filter as follows:

1. Place a suitable container under the fuel tank to collect the fuel;
2. Remove the fuel cap 1;
3. Remove the fuel tank replacement cap 2 and fuel replacement gasket 3;
4. Loosen the nuts of the fuel dispensing valve 1 on both sides of the valve 2;
5. Remove and discard the O-rings 3;
6. Remove the outlet fuel filter 4 and gasket 5 from the fuel tank fill point 6;
7. Install a new outlet fuel filter 4 and gasket 5 through the fill point of the fuel tank 6 and seat it in the fuel tank;
8. Install a new O-ring 9 on the fuel control valve 8 and secure the assembly to the fuel tank using the nuts 7 of the fuel delivery valve;
9. Tighten the fuel tank replacement cap 2 with the new gasket 3;
10. Replace the fuel cap 1 and hand tighten it. Pay attention that overtightening the fuel cap will damage it. Fill the fuel tank.

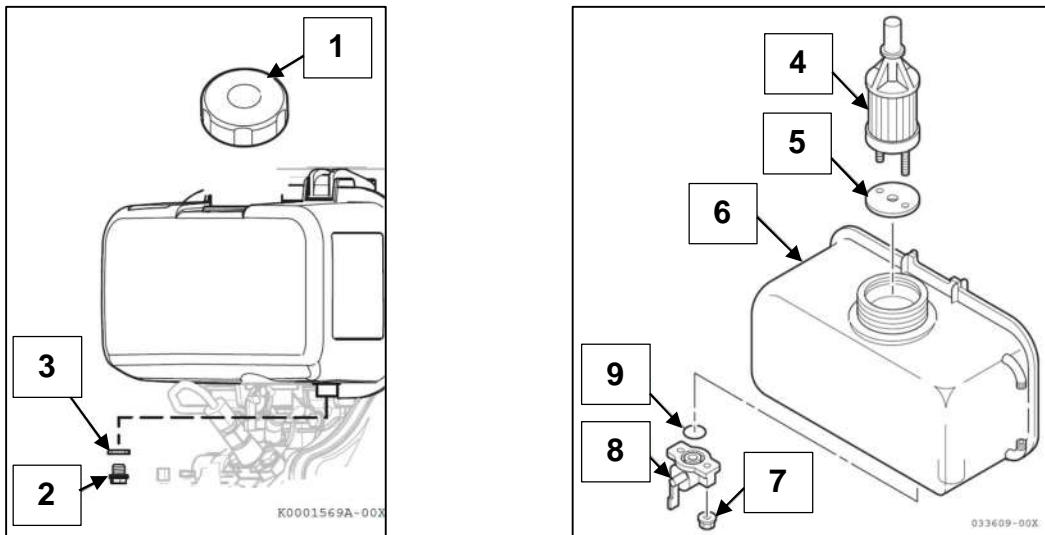

Emptying the tank and replacing the outlet filter

10.5.10 Generator cleaning

Perform a thorough cleaning of the generator.

- If not well maintained, various parts may become damaged or even corroded;
- Clogging of the combustion air holes can compromise generator performance.
- For exceptionally difficult conditions, anti-rust and/or anti-corrosion spray is recommended;
- In addition to periodic cleaning, all connections must be checked for leaks and there is no evidence of overheating or damaged cables.

10.5.11 Maintenance of the batteries

The PAGURO generator is negative grounded. For electric starting install a 12V battery of 90Ah (not supplied). Refer to the recommendations of the battery manufacturer and then schedule a systematic maintenance of the batteries on board, including:

- Monitor your voltmeter for proper charging during generator operation;
- Make certain that battery cable connections are clean and tight to the battery posts (and to your generator);
- Keep your batteries clean and free of corrosion;

- Check the voltage of the starting battery. This battery should have a voltage between 13 and 14 volts when the generator is running. If not, there is a problem in the battery charging circuit by checking the wiring and connections, the solenoid, isolator, battery switch, and the battery itself.



WARNING! Sulfuric acid in lead batteries can cause severe burns on skin and damage clothing. Wear protective gear.



WARNING! Wear rubber gloves, a rubber apron and eye protection when servicing batteries. Lead acid batteries emit hydrogen, a highly explosive gas, which can be ignited by electrical arcing or a lighted cigarette, cigar or pipe. Do not smoke or allow an open flame near the battery being serviced. Shut off all electrical equipment in the vicinity to prevent electrical arcing during servicing.



Switch off any electrical equipment near the batteries in order to avoid ignition sources of flames/sparks during maintenance.

10.5.9 Endothermic engine maintenance

Refer to the procedures in Attachment 1A for all other endothermic engine maintenance information not listed in this manual.

10.6 STORAGE OF THE GENERATOR

If the generator is to be stored for 1 to 6 months, carry out the following operations:

- Drain seawater from the pump;
- Close the engine exhaust and intake properly with adhesive tape.
- Replace oil and the engine oil filter.
- Replace the fuel filter;
- Cover the generator with a nylon cloth and place it on a wooden floor.

NOTE: For storage more than 6 months please contact the Manufacturer **VTE S.r.l.**

11. TYPES OF RISKS AND SAFETY PICTOGRAMS INCLUDED

11.1 RISKS OF A MECHANICAL NATURE

This paragraph describes the mechanical risks that can arise during installation or maintenance operations on the generator, the risks that they can generate and the protections that have been adopted. Normally these risks do not affect the operator since protections are enabled during ordinary operation and the risks have been eliminated or reduced.

During maintenance, the risks are partially reduced if the safe method of intervention is implemented by placing the generator in maintenance state. Any special circumstances will be indicated in the following points. When carrying out repairs or other extraordinary work, the risks outlined in the following points must be considered.

11.1.1 Generator stability

The generator correctly installed has not instability or overturning risks.
Observe the instructions given in par. 5.2 "Fixing the generator" for proper installation.

11.1.2 Breakage dangers during the functioning of the generator

The safety of the generator depends proportionally by the respect of the times and the modes required for the periodic check, the maintenance, the cleaning and the replacement of the worn parts.



WARNING! It is necessary to:

- observe the envisioned timeframes (see par. 10.2.7 "Ordinary maintenance table");
- use original spare parts;
- follow the procedures indicated in the User and Maintenance Manual and/or by the manufacturer of the specific spare parts;
- assign skilled staff to perform the procedures (maintainers).

Failure to do so relieves the Manufacturer of all liability.

No mechanical parts are exposed to corrosion or stress that could lead to dangerous.



WARNING! IT IS FORBIDDEN TO:

- place objects on the generator.
- use the soundproofing capsule as a support or work surface.

11.1.3 Dangers and risks caused by flying objects

The parts that can be a source of danger are normally protected by protective carter, in order to guarantee safety conditions.

Lack of maintenance or failure to observe the maintenance schedules indicated by the Manufacturer may cause the fluid circuit elements (pipes, fittings, etc.) to wear early and also cause fluid leakage.

Sudden leaks from the fluidic circuits can damage the generator and compromise its operation.



WARNING! IT is always mandatory to secure all guards in place before operating the generator.

11.2 DESIGN AND PHYSICAL FEATURES OF SAFETY GUARDS

The generator is protected by a multilayer fiberglass capsule, lined internally with sound-absorbing material, consisting of:

- N.1 lower containment element of the generator equipped with anti-vibration system.
- N.2 upper elements with interlocking profiles, held together by silicone elastic bands.

The guards ensure safe disassembly without the use of tools.

The guards used are of robust construction, are suitable to withstand normal working stress and do not allow the contact of dangerous parts through the human body.



After any operation and before starting the generator, it is essential to refit and secure the removed guards.

11.3 SAFETY PICTOGRAMS ON-BOARD THE GENERATOR

The table on the following page lists the safety pictograms applied to the generator in the vicinity of the most dangerous areas.



IMPORTANT! This safety signs shall not be removed in any case. If the pictogram is damaged so that it is unreadable, it is obligatory to replace it with another one having the same dimensions, images and colour.

SAFETY PICTOGRAMS		BEHAVIORAL STANDARD
	Danger of extreme temperatures.	Pay attention to parts that generate or are subjected to extreme temperatures. Wear suitable Personal Protective Equipment.
	No protection removal.	Do not remove the protections installed when the generator is functioning.

11.4 ELECTRICAL RISKS

The electric system project, the connections to the protective circuit, the quality and the arrangement of the components assure the prevention from the risks arising from the electric supply. The generator must be protected against overloads by a magnetothermal circuit breaker.

11.5 OTHER NATURE RISKS OR RESIDUAL RISKS

11.5.1 Risk of fire

The generator uses diesel fuel and engine oil, which can cause fire if it comes into contact with parts that are generating or subjected to extreme temperatures. The safety of the generator against fire is intricately linked to maintenance operations and to the observance of the timing. In the event of a fire, switch off using suitable fire extinguishers.



With the generator in operation it is absolutely forbidden stop the fire with water.

11.5.2 Risk of explosion

The generator uses diesel and batteries which, in the event of contact with open flames, could cause an explosion.

The safety of the generator from explosions is intricately linked to the maintenance operations and to the compliance with the procedures indicated in this manual (see chap. 9 "GENERAL SAFETY INFORMATION").

11.5.3 Dangers and risks from toxic exhaust gases

Although the exhaust gases of diesel engines are not as toxic as those of petrol engines, carbon monoxide is also present in the exhaust gases of diesel engines. Some of the symptoms or signs of Carbon Monoxide inhalation/poisoning are as follows:

- | | |
|--------------|---------------------------------|
| - Vomiting; | - Muscle spasms; |
| - Nausea; | - Delayed movements; |
| - Dizziness; | - Weakness and drowsiness; |
| - Migraine; | - Inability to think correctly. |



WARNING! If these symptoms occur, go out to the open air immediately. If symptoms persist, seek medical attention. Switch off the generator and do not operate it again until it is inspected and repaired.

To prevent the risk of exhaust fumes, follow these guidelines:

- Do not use copper pipes in the exhaust system. Diesel fumes can quickly destroy copper pipes in exhaust systems.
- Do not install the exhaust gas outlet near doors, portholes, or air conditioning. If the exhaust gas outlet is near the waterline, the water in the exhaust line may block or restrict the flow of gases to the outside. Do not overload the boat.



WARNING! In addition to regular exhaust line checks, install a Carbon Monoxide detector. Consult your boat Manufacturer for detector selection.

11.5.4 Dangers and risk arising from parts subject to extreme temperatures

An endothermic engine can reach high temperatures, particularly in particularly hot environments. Possible risks of burns and burns are considered negligible as during operation the generator is protected by safety guards that prevent the body from coming into contact with parts subject to extreme temperatures.

PAGURO 3SY / 4SY

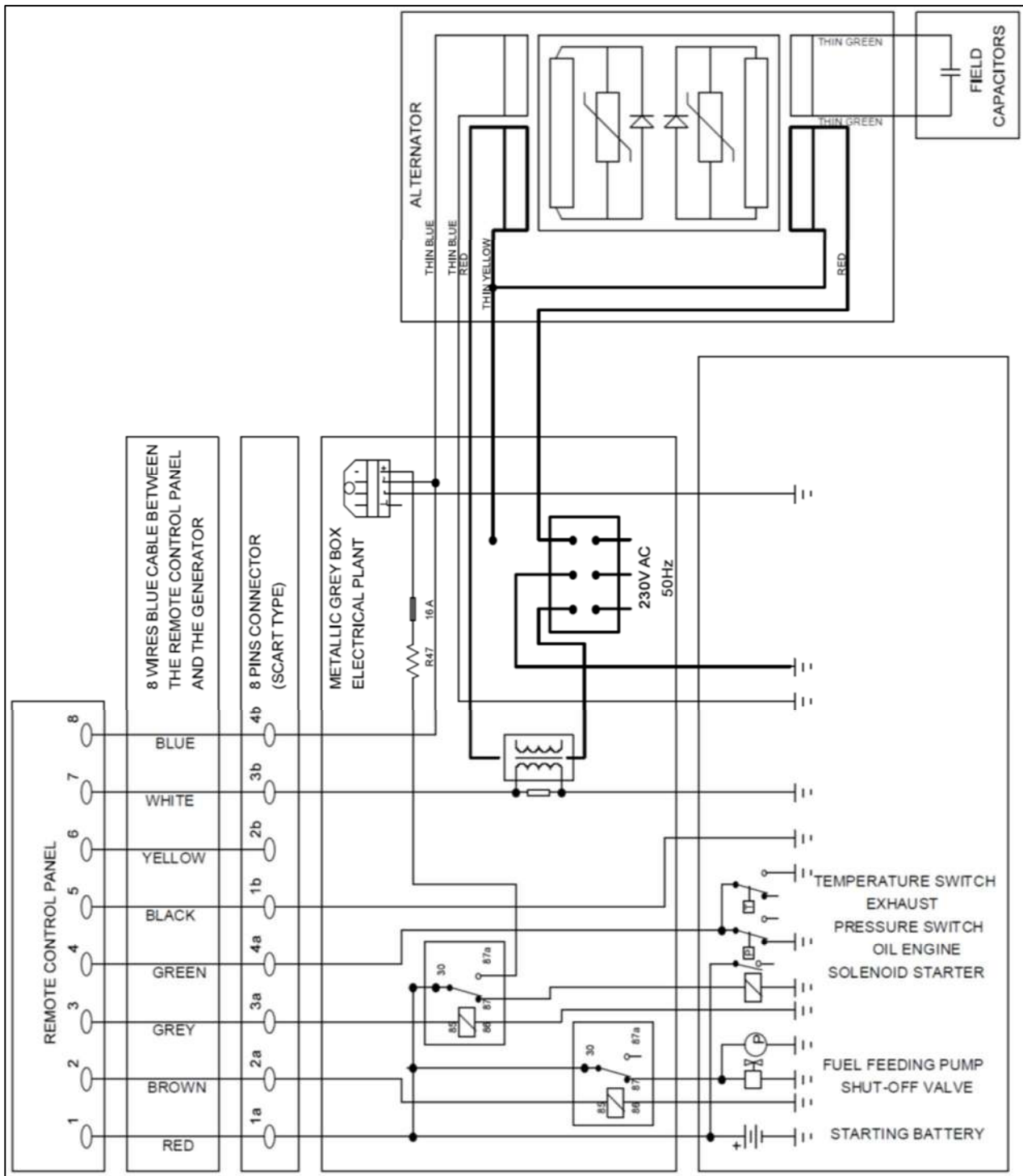

PAGURO 5.5SY

ALTERNATOR DRAWING PAGURO 3SY / 4SY

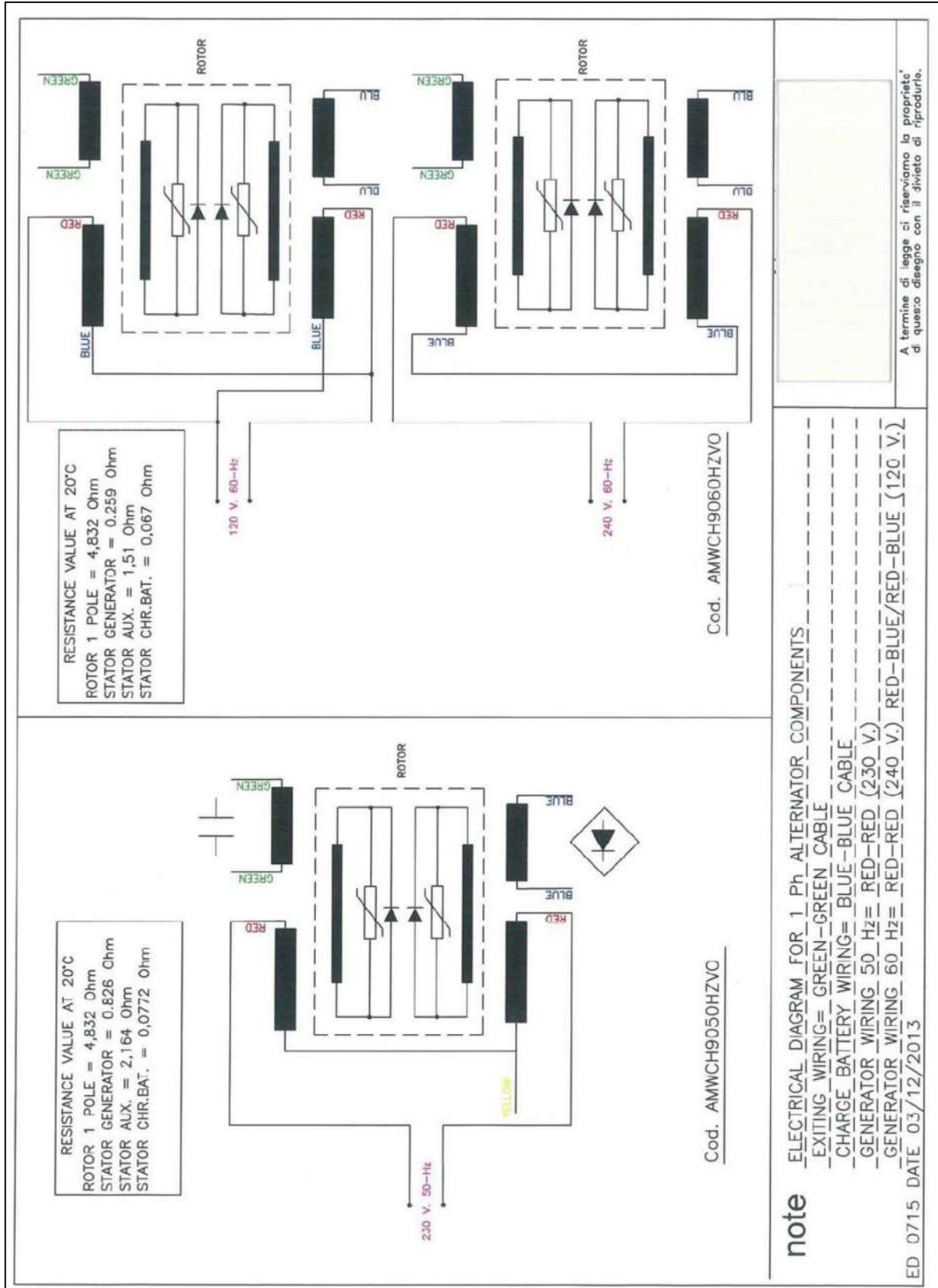

ALTERNATOR DRAWING PAGURO 5.5 SY

ATTACHMENTS

Attachment 1:

- A. User and Maintenance Manual – *Yanmar* Endothermic motor.



VTE Srl – Via Luciano Lama, 5 – 33050 Fiumicello (UD) – Italy
Phone: +39 0431 96488 – e-mail: info@volpитеcno.com
Website: www.volpитеcno.com