

Installation Manual

Dual 200 Amp - Split 400 Amp Automatic Transfer Switch

with Service Disconnect and
AC Power Control Module™

Questions?

Help is just a moment away!

Call: Transfer Switch Helpline

800-743-4115

Monday - Friday 8:00 AM - 5:00 PM Central Standard Time



Thank you for your purchase of this Briggs & Stratton Power Products® automatic transfer switch. This product is designed for use with specific home standby generators and may not function with generators or remote modules produced by other manufacturers. Seek a qualified electrical professional to determine applicability of this equipment to equipment manufactured by others. When operated and maintained according to the instructions in this manual, your system will provide many years of dependable service.

This manual contains safety information to make you aware of the hazards and risks associated with this system and how to avoid them. We have made every effort to provide for a safe, streamlined and cost-effective installation. As each installation is unique, it is impossible to know of and advise of all conceivable procedures and methods by which installation might be achieved. We do not know all possible hazards and/or the results of each possible method or procedure. It is important that you read and understand these instructions thoroughly before attempting to install or operate this equipment. **Save these original instructions for future reference.**

This transfer switch requires professional installation before use. Refer to the Installation section of this manual for instructions on installation procedures. Only licensed electrical contractors should install transfer switches. Installations must strictly comply with all applicable federal, state and local codes, standards and regulations. Your installer should follow the instructions completely.

Where to Find Us

You never have to look far to find Briggs & Stratton support and service for your system. Consult your Yellow Pages. There are many authorized service dealers who provide quality service. You can also contact Technical Service by phone at 800-743-4115 between 8:00 AM and 5:00 PM CT, or click on Find a Dealer at BRIGGSandSTRATTON.COM, which provides a list of authorized dealers.

For Future Reference

Please fill out the information below and keep with your receipt to assist in unit identification for future purchase issues.

Model Number	<input type="text"/>	<input type="text"/>	<input type="text"/>	<input type="text"/>	<input type="text"/>	<input type="text"/>	<input type="text"/>		
Revision	<input type="text"/>	<input type="text"/>							
Serial Number	<input type="text"/>	<input type="text"/>	<input type="text"/>	<input type="text"/>	<input type="text"/>	<input type="text"/>	<input type="text"/>	<input type="text"/>	<input type="text"/>
Date Purchased	<input type="text"/>	<input type="text"/>	<input type="text"/>	<input type="text"/>	<input type="text"/>	<input type="text"/>			

Copyright © 2011. Briggs & Stratton Power Products Group, LLC
Milwaukee, WI, USA. All rights reserved.
Briggs & Stratton Power Products is a registered
trademark of Briggs & Stratton Corporation
Milwaukee, WI, USA

Table of Contents

Important Safety Instructions	4
Installation	5
Owner Responsibilities	5
Owner Orientation	5
Installing Dealer/Contractor Responsibilities	5
Equipment Description	5
Delivery Inspection	6
Mounting Guidelines	6
Power Wiring Interconnections	7
Supervisory Control Wiring	8
System Setup	12
Testing the Automatic Transfer Switch	13
Controls	13
Operation	13
Transfer Switch Wiring Diagram	14
Transfer Switch Schematic Diagram	15
Troubleshooting	16
Product Specifications	16

NOT
for
REPRODUCTION

Save These Instructions

Important Safety Instructions

SAVE THESE INSTRUCTIONS - This manual contains important instructions that should be followed during installation of the equipment.

Safety Symbols and Meanings



Electrical Shock



Read Manual

▲ The safety alert symbol indicates a potential personal injury hazard. A signal word (DANGER, WARNING, or CAUTION) is used with the alert symbol to designate a degree or level of hazard seriousness. A safety symbol may be used to represent the type of hazard. The signal word **NOTICE** is used to address practices not related to personal injury.

▲ **DANGER** indicates a hazard which, if not avoided, will result in death or serious injury.

▲ **WARNING** indicates a hazard which, if not avoided, could result in death or serious injury.

▲ **CAUTION** indicates a hazard which, if not avoided, could result in minor or moderate injury.

NOTICE addresses practices not related to personal injury.

The manufacturer cannot possibly anticipate every possible circumstance that might involve a hazard. The warnings in this manual, and the tags and decals affixed to the unit are, therefore, not all-inclusive. If you use a procedure, work method or operating technique that the manufacturer does not specifically recommend, you must satisfy yourself that it is safe for you and others. You must also make sure that the procedure, work method or operating technique that you choose does not render the equipment unsafe.

▲ **WARNING** Certain components in this product and related accessories contain chemicals known to the State of California to cause cancer, birth defects, or other reproductive harm. Wash hands after handling.

NOTICE Only qualified, licensed electricians should attempt installation of this equipment, which must strictly comply with applicable codes, standards and regulations.

▲ **WARNING** Shock Hazard. Installing low and high voltage wire in same conduit could result in death, serious injury and/or property damage.

- Do not run low and high voltage wire in the same conduit unless the insulation rating on ALL wiring is rated for 600V. See NEC for more information.

▲ **WARNING** Failure to properly ground equipment could cause electrocution resulting in death or serious injury.

- Do not touch bare wires.
- Do not use equipment with worn, frayed, bare or otherwise damaged wiring.
- Do not handle electrical cords while standing in water, while barefoot, or while hands or feet are wet.
- If you must work around a unit while it is operating, stand on an insulated dry surface to reduce shock hazard.
- Do not allow unqualified persons or children to operate or service equipment.
- In case of an accident caused by electrical shock, immediately shut down all sources of electrical power and contact local authorities. Avoid direct contact with the victim.

▲ **WARNING** Shock hazard. Equipment contains high voltage that could result in death, serious injury and/or property damage.

- DO NOT operate this equipment imprudently or neglect its maintenance.

NOTICE Improper treatment of equipment could damage it and shorten its life.

- Use equipment only for intended uses.
- If you have questions about intended use, ask dealer or contact Briggs & Stratton Power Products.
- Do not expose equipment to excessive moisture, dust, dirt, or corrosive vapors.
- Remain alert at all times while working on this equipment. Never work on the equipment when you are physically or mentally fatigued.
- If connected devices overheat, turn them off and turn off their circuit breaker/fuse.

Installation

We sincerely appreciate your patronage and have made significant effort to provide for a safe, streamlined and cost-effective installation. Because each installation is unique, it is impossible to know of and advise the trade of all conceivable procedures and methods by which installation might be achieved. Neither could we know of possible hazards and/or the results of each method or procedure.

For these reasons, **only current licensed electrical professionals should attempt system installations. Installations must strictly comply with all applicable codes, industry standards and regulations.**

Your equipment is supplied with this Installation Manual and a separate Operator's Manual. These are important documents and should be retained by the owner after the installation has been completed.

Every effort has been made to make sure that the information in this manual is both accurate and current. However, the manufacturer reserves the right to change, alter or otherwise improve the system at any time without prior notice.

Owner Responsibilities

To help you make informed choices and communicate effectively with your installation contractor(s), **read and understand Owner Orientation before contracting or starting your equipment installation.**

To arrange for proper installation, contact the store at which you purchased your equipment, your dealer, or your utility power provider.

The equipment warranty is VOID unless the system is installed by licensed electrical professionals.

Owner Orientation

The illustrations provided are for typical circumstances and are meant to familiarize you with the installation options available with your system.

Local codes, appearance, and distances are the factors that must be considered when planning an installation. As the distance from the existing electrical service increases, compensation in wiring materials must be allowed for. This is necessary to comply with local codes and overcome electrical voltage drops.

These factors will have a direct effect on the overall price of your equipment installation.

Your installer must check local codes AND obtain permits before installing the system.

- Read and follow the instructions given in this manual.
- Follow a regular schedule in caring for and using your equipment, as specified in this manual.

Installing Dealer/Contractor Responsibilities

- Read and observe the Important Safety Instructions.
- Read and follow the instructions given in this manual.
- The installer may need to provide appropriate rated contactors based on loads to be controlled.
- Check federal, state and local codes and authority having jurisdiction, for questions on installation.
- Ensure generator is not overloaded with selected loads.

If you need more information about the transfer switch, call 800-743-4115, between 8:00 AM and 5:00 PM CST.

Equipment Description

The transfer switch is designed to transfer selected loads found in normal residential installations to standby power in the event of a primary power outage. The load is connected either to utility power (normal) or standby power (generator). The transfer switch monitors utility and generator voltages and will automatically connect loads to the appropriate source of power.

Only a licensed electrician should complete a standby installation. Service conduit and conductors can be wired directly from the watt-hour meter to the transfer switch. A separate service entrance disconnect and associated wiring is not required when installed per applicable federal, state and local codes, standards and regulations.

Major components of the transfer switch are three, 2-pole circuit breakers (one for generator disconnect and two for utility disconnect), two, 2 pole double throw transfer switches, transfer switch control circuit board, fused utility terminals and interconnecting wiring. All of these components are housed in a NEMA 3R enclosure that is suitable for both indoor and outdoor installations.

The transfer switch is solenoid-operated from utility or generator inputs and contain suitable mechanical and electrical interlock switches to eliminate the possibility of connecting the utility service to the generator output. It has ratings capable of switching full utility power into the residence. In addition, a manual override lever is provided for the transfer function.

The control board has active circuits sensing utility and generator voltages. It creates a signal for generator start-up, switch transfer and retransfer when utility is restored. The control board also contains red and green LEDs indicating the power source available and two relay operated contacts that provide supervisory control of external loads.

Delivery Inspection

After opening the carton, carefully inspect the transfer switch components for any damage that may have occurred during shipment.

If loss or damage is noted at time of delivery, have the person(s) making delivery note all damage on the freight bill and affix their signature under the consignor's memo of loss or damage. If loss or damage is noted after delivery, contact the carrier for claim procedures. Missing or damaged parts are not warranted.

Shipment contents:

- Automatic transfer switch
- Installation and operator's manuals
- Current transformers (2)

To be supplied by installer:

- Connecting wire and conduit
- Various specialty tools/equipment

Mounting Guidelines

The transfer switch system circuitry is enclosed in a NEMA Type 3R enclosure suitable for indoor/outdoor use. Guidelines for mounting the enclosure include:

- Install enclosure on a firm, sturdy supporting structure.
- The transfer switch enclosure must be installed with minimum NEMA 3R hardware for conduit connections.
- To prevent switch contact distortion, level and plumb the enclosure. This can be done by placing washers between the enclosure and the mounting surface.

- NEVER install the switch where any corrosive substance might drip onto the enclosure.
- Protect the switch at all times against excessive moisture, dust, dirt, lint, construction grit and corrosive vapors.

A typical automatic transfer switch installation is depicted below. It is best if the transfer switch is mounted near the utility meter, either inside or outside. Discuss layout suggestions/ changes with the owner before beginning the system installation process.

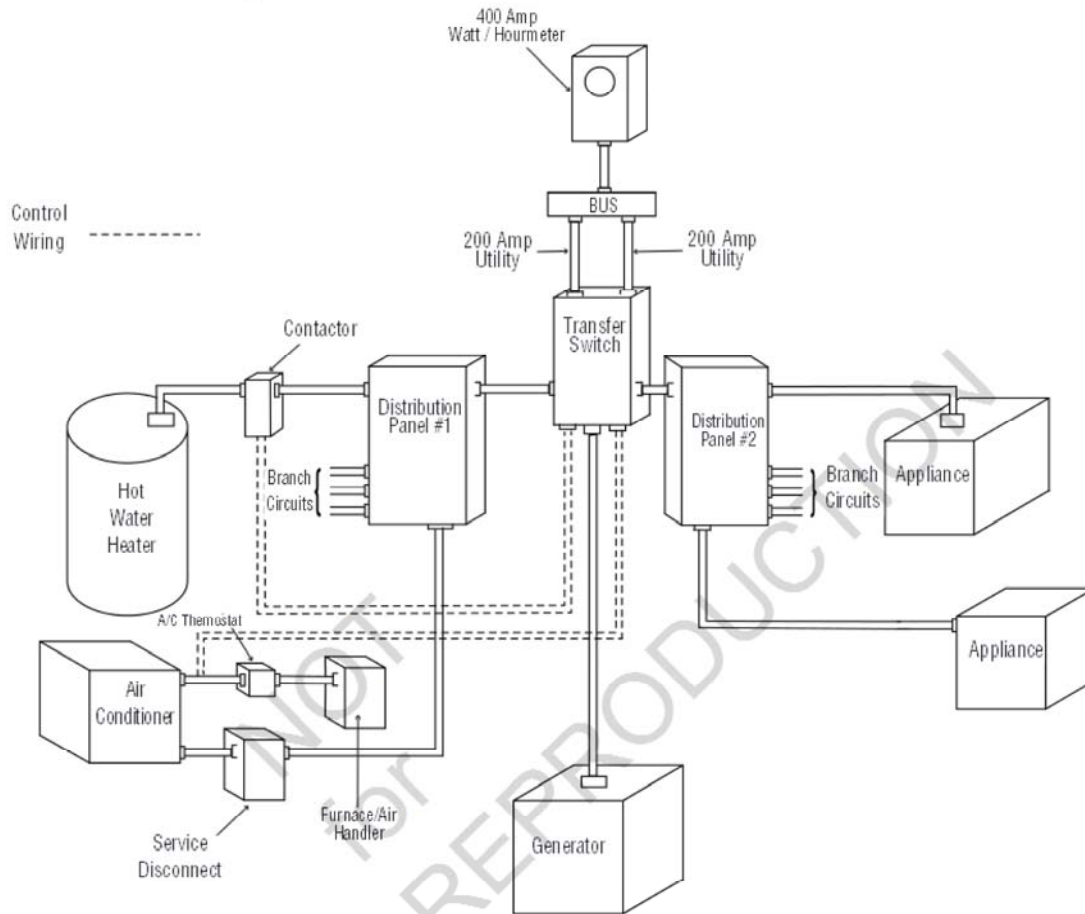

NOTICE: The load outputs of the transfer switch can supply one 200 Amp panel each. These outputs **MUST NOT** be combined, or used individually to supply a panel larger than 200 Amps.



Incorrect!



Incorrect!

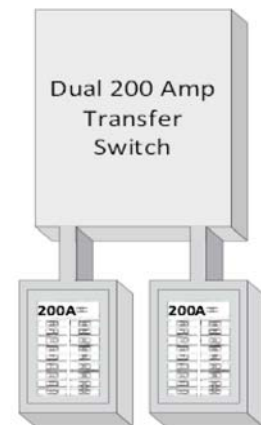

Correct

Power Wiring Interconnections

NOTICE Improper installation could cause damage to the circuit boards and shorten their life. Installing circuit boards in live circuits will damage the board and is not covered by warranty. ALWAYS disconnect ALL sources of power prior to servicing.

- Remove all power prior to installing this equipment. Failure to do so could cause internal damage to the board when making electrical connections.
- Turn generator to OFF position.
- Turn off utility power to the standby generator and transfer switch.

All wiring must be the proper gauge, properly supported and protected by conduit. All wiring should be done per applicable federal, state and local codes, standards and regulations. Obey wire type and torque specifications printed on the terminal blocks, neutral/ground connectors, and installation instructions.

⚠ WARNING Shock Hazard. Installing low and high voltage wire in same conduit could result in death, serious injury and/or property damage.



- Do not run low and high voltage wire in the same conduit unless the insulation rating on ALL wiring is rated for 600V. See NEC for more information.

Use installer supplied 600VAC or greater copper wire of a gauge that complies with the latest version of the National Electric Code to complete the following connections between utility power, transfer switch, generator, and main distribution panel. Apply the necessary correction factors and wire size calculations. Refer to the illustration on pages 9 and 10 for component location.

1. Set generator's circuit breaker to **OFF** position.
2. Set generator's system switch to **OFF** position.
3. Remove 15 Amp fuse from generator control panel.
4. Turn off utility power to the standby generator and transfer switch.
5. Locate both 200 Amp utility line circuits coming from the utility meter.
6. Connect one 200 Amp utility service line circuit to one transfer switch service disconnect circuit breaker. The terminal is marked "Utility Connection" (**Z1**). Repeat for second 200 Amp utility service line circuit (**Z2**).

NOTICE: DO NOT wire 400 Amp utility line to this Automatic Transfer Switch.

7. Connect utility service neutral to transfer switch neutral terminal (**H1** or **H2**).
8. Connect main distribution panel feeder from first distribution panel conductors (**R1**) to transfer switch terminals marked "LOAD CONNECTION (**V1**)".
9. Connect main distribution panel feeder from second distribution panel conductors (**R2**) to transfer switch terminals marked "LOAD CONNECTION (**V2**)".

NOTICE The two individual transfer switch terminals marked "Load Connection" (**V1** and **V2**) must be connected to separate distribution panels.

NOTICE Connect the neutrals from both main distribution panels (**S1** and **S2**) to the transfer switch neutral terminal (**H1** and **H2**).

10. Connect two main distribution panel grounds (**T1** and **T2**) to transfer switch "GND" terminal (**U1** or **U2**).

Assure grounding electrode conductor is connected and bonded per applicable federal, state and local codes, standards and regulations.

11. Connect feeder conductors from transfer switch breaker "GENERATOR CONNECTION" terminals (**Y**) to generator circuit breaker LINE1 and LINE2 terminals (**M**). Each conductor must pass through hole of current transformer (**B1** and **B2**) before making connection.

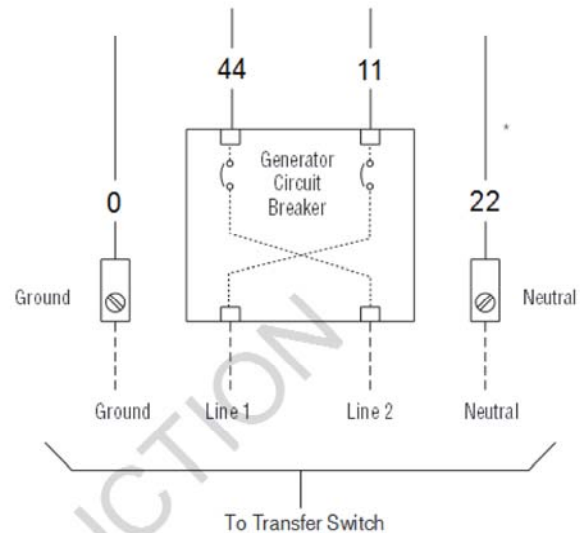

12. Plug current transformer leads into "CT1" and "CT2" terminals (**E1** and **E2**) on transfer switch control board.

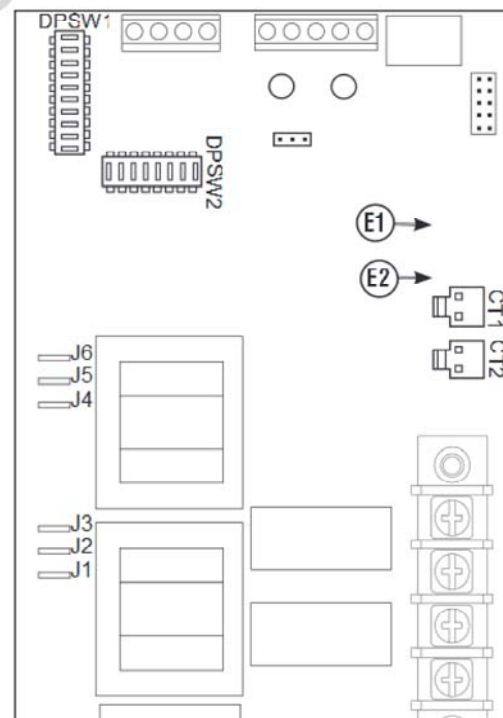

13. Connect conductor from transfer switch neutral terminal (**H1** or **H2**) to generator NEUTRAL terminal (L). Observe generator control panel labeling for terminal identification.
14. Connect conductor from transfer switch "GND" terminal (**U1** or **U2**) to generator control panel "GROUND" terminal (K).
Assure generator equipment grounding conductor (**G**) is connected per applicable federal, state and local codes, standards and regulations.
15. Using minimum #14 AWG conductors, connect the transfer switch "UTILITY 240 VAC" terminals to generator's "240 VAC" terminals via two-pole connector supplied with generator (**P**).
16. Using #18 AWG twisted pair copper conductors, no greater than 200 ft. in length, 300 volt minimum, and 75°C minimum, connect "T/R" and "GND" terminals (**B**) on transfer switch control board to the generator's control panel "TxRx" and "TxRx GND" terminals via ten pin connector (**A**) supplied with generator. Count down to the proper pin location on the generator control board since visual alignment with its decal can be misleading:
17. Tighten all wire connections/fasteners to proper torque.

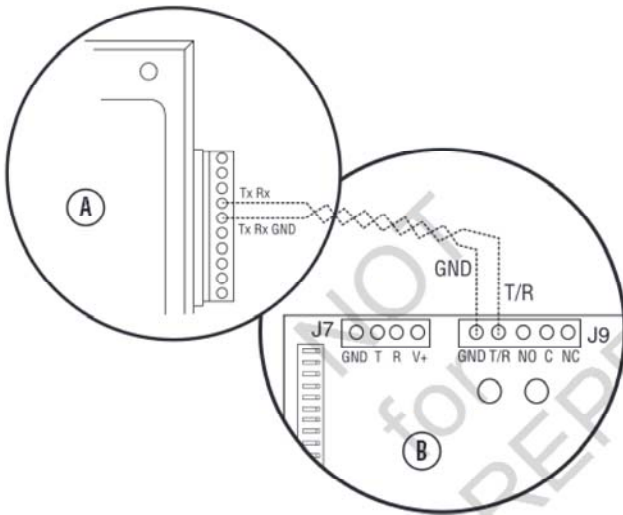

Supervisory Control Wiring

An air conditioner can be used with the supervisory contacts on either terminals A-A or B-B. Terminals A-A can only be used with supervisory control. Large loads can only be used with contactor control on terminals B-B. Examples of each system are described below.

1. The terminal strip on the transfer switch control board has four connections for customer use. There are two sets of "Normally Closed" contacts available. They will be activated when generator power is required. These can be used for supervisory control of large connected loads on generator. Loads will be allowed to operate if there is enough generator power available.

For installer convenience, there are two wireways provided to help keep supervisory load wires organized.

2. Terminals "A-A" on transfer switch control board are rated for 24VAC. Connect these contacts in series between air conditioner thermostat and air conditioner contactor.

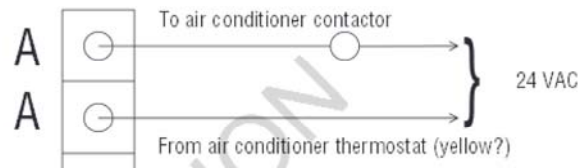

3. Terminals "B-B" on transfer switch control board are rated for 1 Amp 125 VAC. When connected with an installer supplied contactor, it can be used to control a large load, such as an electric hot water heater. Contacts are connected in series with the contactor control circuit.

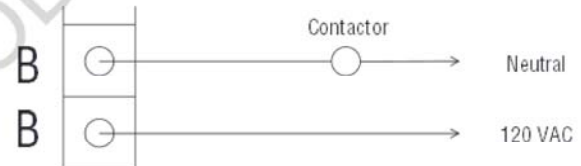

Interconnection Diagram

The illustration on the following pages shows a completed transfer switch installation. Each installation layout may vary.

Illustration callouts are:

- A1** - From Utility to First Service Panel
- A2** - From Utility to Second Service Panel
- B1** - Current Transformer
- B2** - Current Transformer
- C** - Dipswitches
- D** - T/R and GND to Generator
- E** - CT Terminals
- F** - Transfer Switch Contactors
- G** - UTILITY 240VAC to Generator
- H1** - Transfer Switch Neutral Terminal
- H2** - Transfer Switch Neutral Terminal
- J** - Generator
- K** - Generator Ground Terminal
- L** - Generator Neutral Terminal
- M** - Generator Circuit Breaker
- N** - Ten pin Connector
- P** - Two pin Connector
- R1** - Main Distribution Panel 1
- R2** - Main Distribution Panel 2
- S1** - Distribution Panel Neutral Bus
- S2** - Distribution Panel Neutral Bus
- T1** - Distribution Panel Ground Bus
- T2** - Distribution Panel Ground Bus
- U1** - Transfer Switch Ground Terminal
- U2** - Transfer Switch Ground Terminal
- V1** - Load Connections to Distribution Panel 1
- V2** - Load Connections to Distribution Panel 2
- W1** - Service Entrance Breaker - UTILITY 1
- W2** - Service Entrance Breaker - UTILITY 2
- X** - Generator Disconnect
- Y** - Generator Connection
- Z1** - Utility Connection
- Z2** - Utility Connection

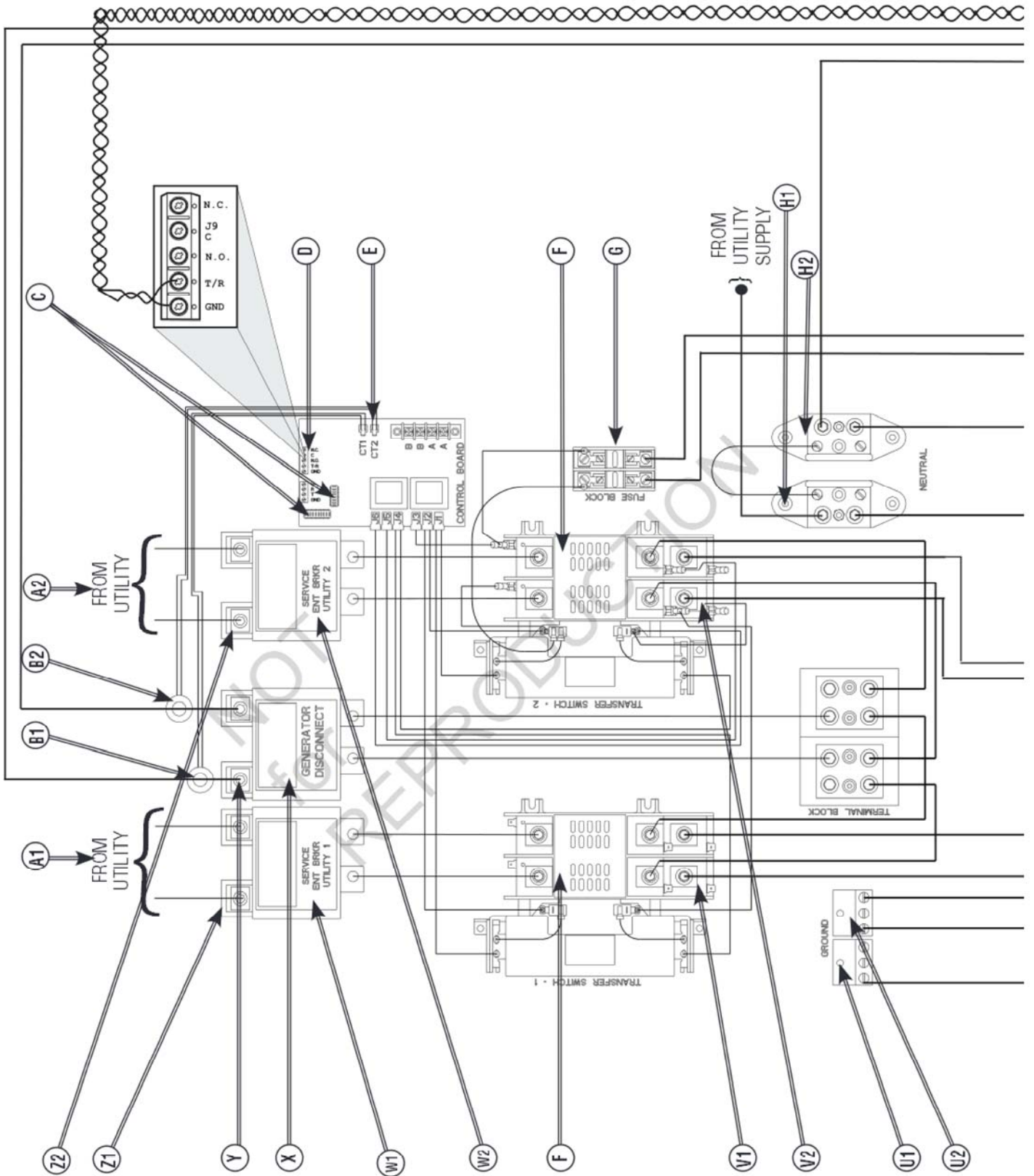

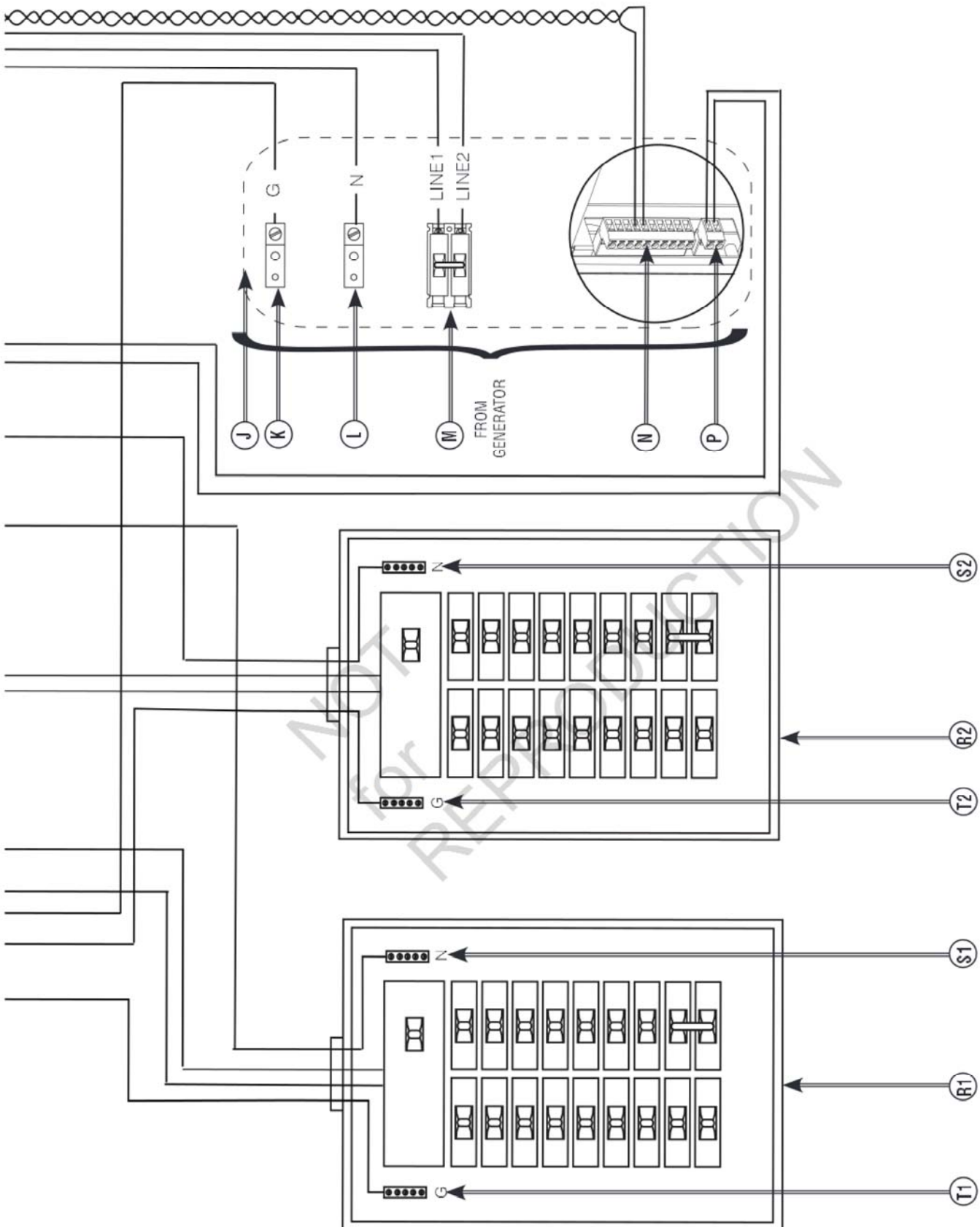

System Setup

You must perform the following before operating the system:

- If generator is installed in an area regularly subjected to temperatures below 40°F (4°C), select a 50 second warm up time by moving jumper JP2 (C) installed on transfer switch control board from '20' position to '50' position.
- Set the DPSW1 (A) and DPSW2 (B) dipswitches on the transfer switch control board to match the kW rating of the standby generator, as described in Setting Dipswitches.

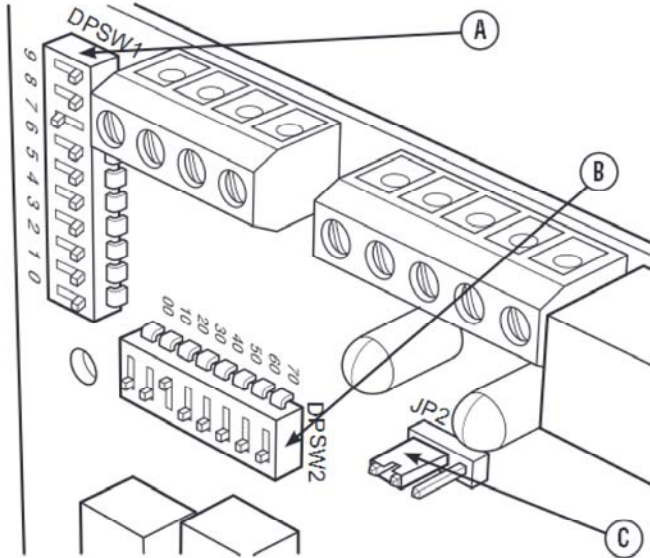

Setting Dipswitches

Dipswitches are used to adjust control board operation based on generator capacity. DPSW1 and DPSW2 switches are set to correspond to total system kW rating. Dipswitch DPSW1 (A) has units of 1,000 watts; Dipswitch DPSW2 (B) has units of 10,000 watts.

Set dipswitches with utility and generator power removed from the transfer switch to ensure proper control system operation.

If dipswitches are set when power is present at transfer switch, a power reset needs to be performed before the new dipswitch settings will take effect. Power reset is when all power is removed from the transfer switch and then reintroduced after 30 seconds.

NOTICE An FC_8 will occur on standby generator control board if dipswitches are not properly established as noted above.

NOTICE Use extreme caution when setting dipswitches or damage to control board will result.

- Use a pencil or small piece of plastic to set the dipswitch.
- NEVER use a screwdriver or any type of metal object to set dipswitches.

The "On" position for the dipswitches is the switch number ON THE TRANSFER SWITCH CONTROL BOARD, not on the switch. For example, for an 18,000 watt generator, set DPSW2 dipswitch 10 to "On" position. Set DPSW1 dipswitch 8 to "On" position. 10,000 plus 8000 equals 18,000 watts. Set only one switch to "On" position on DPSW1 and DPSW2.

Refer to following chart for proper switch selection(s).

kW Rating of Generator	A DPSW #1 "ON" Position	B DPSW #2 "ON" Position
7kW	7	0
8kW	8	0
9kW	9	0
10kW*	0	10
11kW*	1	10
12kW	2	10
13kW*	3	10
14kW	4	10
15kW	5	10
16kW	6	10
17kW	7	10
18kW	8	10
19kW	9	10
20kW	0	20
30kW	0	30
45kW	5	40
48kW	8	40
50kW	0	50
60kW	0	60

* For generators with a rating that includes 500 Watts, round down to next lowest rating
(example: 13.5 kW set to 13kW)

NOTICE Air density is less at high altitudes, resulting in less available engine power. Specifically, engine power will decrease 3.5% for each 1,000 feet (300 meters) above sea level and 1% for each 10° F (5.6°C) above 77°F (25°C). Generators located in these conditions must have the transfer switch programmed appropriately for this power decrease.

Testing the Automatic Transfer Switch

Turn both of the utility service disconnect circuit breakers feeding the transfer switch contactors to the OFF position. The system's automatic sequence described below will initiate. To return to utility power, turn the utility service disconnect circuit breakers to the ON position.

Utility Fail

The generator senses when utility voltage is below 70 percent of nominal. Engine start sequence is initiated after 6 second time delay.

Engine Warm-Up

There is a time delay to allow for engine warm-up before transfer. Use jumper on transfer switch control board to select delay of 20 seconds or 50 seconds.

Transfer

Transfer from utility to generator supply occurs after voltage is above set levels and after the initial warm-up period. Minimum engine run time is 5 minutes after transfer.

Utility Pickup

Voltage pickup level is 80 percent of nominal voltage.

Retransfer

Retransfer from generator to utility power is approximately 10 seconds after utility voltage supply is above pickup level and minimum run time is completed.

Engine Cool Down

Engine will run for 60 seconds after retransfer.

Controls

Other than a Manual Override lever, there are no operator controls because this is an automatic transfer switch. The manual override is to be used only by licensed professionals. Information on handle use can be obtained by calling Technical Service at 800-743-4115.

Operation

To select automatic transfer operation, do the following:

1. In the transfer switch, set both utility disconnect circuit breakers to **ON** position.
2. In the transfer switch, set generator disconnect circuit breaker to **ON** position.
3. Install 15 Amp fuse in generator's control panel.
4. Set generator's circuit breaker to **ON** position.
5. Set generator's system switch to **AUTO** position.

The system will now be in automatic operation mode.

When the generator is providing power to the transfer switch, the transfer switch control board is constantly monitoring generator power. If the air conditioner is called to run, and there is sufficient generator power available, the controller will close contacts "A-A" to air conditioner contactor. Contacts "B-B" will open before contacts A-A close. If loads are too great for the generator, contacts A-A and/or B-B will open. When air conditioning is not needed, A_A will open. If enough power is available, B-B will close.

Enclosure Door

To open the transfer switch door, remove the two exterior thumb screws (A) and carefully lift off door.

To close and secure the door, push door closed against enclosure. While in this position, the door can rest on the tab (B) at the bottom of the enclosure. Reinstall both thumb screws to finger tight. Enclosure door **MUST** be closed and secured at all times except when system is being serviced.

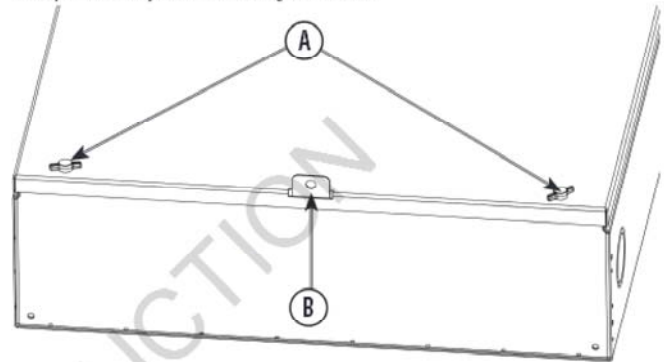

When Calling for Assistance

You must have the Model Number and Serial Number from each transfer switch or remote module ID label at hand if it is necessary to contact a local service center regarding service or repair. Obtain this information from the unit ID labels located on or inside device. For convenience, record the information on the inside front cover of this manual.

To contact Briggs & Stratton call **800-743-4115**, between 8:00 AM and 5:00 PM CT.

Installation Inspection

Before placing the system into service, inspect the entire installation carefully.

This completes the installation and startup instructions. The operator's manual provides full details on Operation, Maintenance, and Troubleshooting for the Automatic Transfer Switch.

Transfer Switch Wiring Diagram

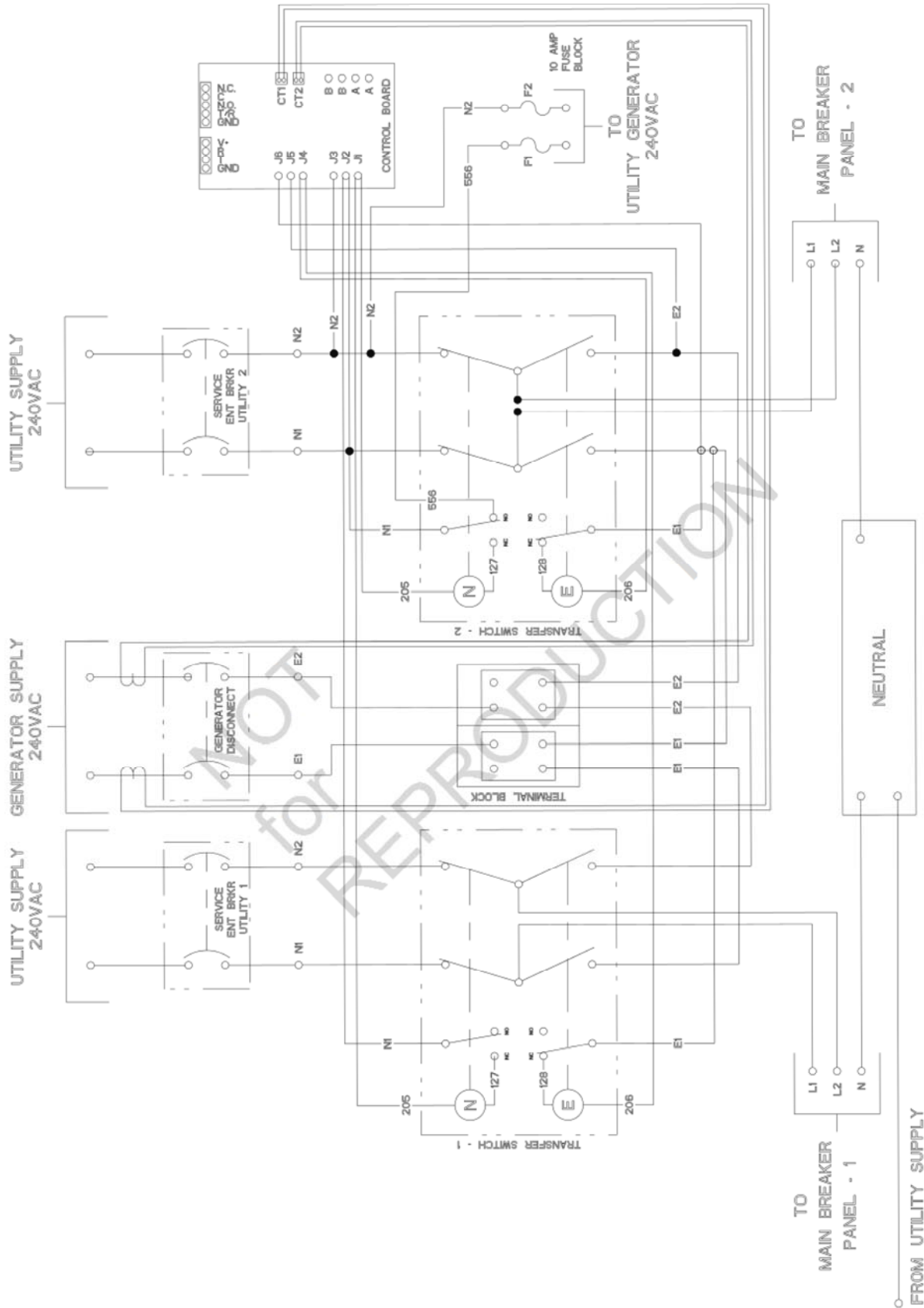

Transfer Switch Schematic Diagram

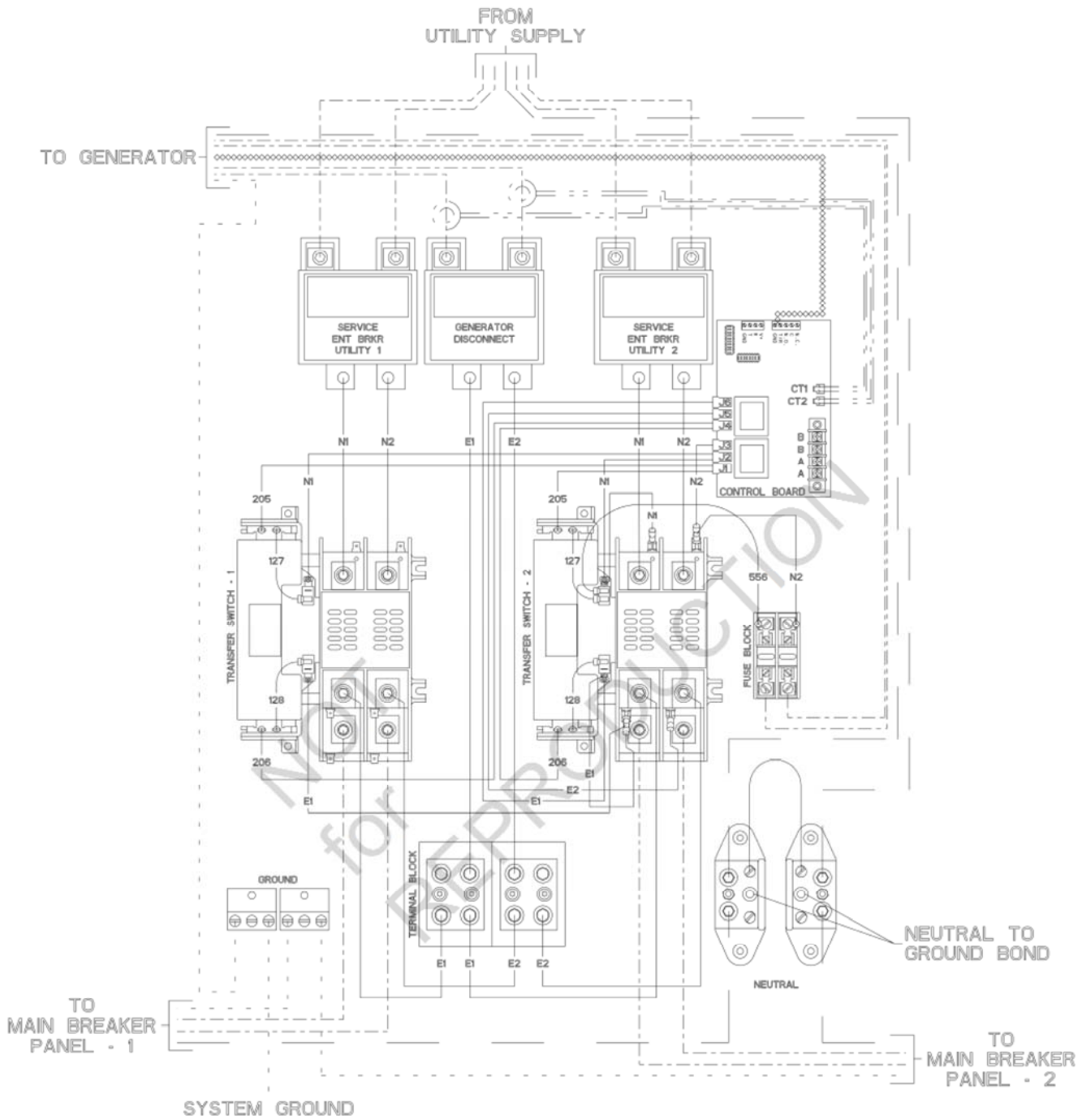

Troubleshooting

Problem	Cause	Correction
Automatic transfer switch does not transfer to generator	<ol style="list-style-type: none"> 1. Generator breaker open. 2. Generator voltage not acceptable. 3. Generator disconnect circuit breaker open in transfer switch. 	<ol style="list-style-type: none"> 1. Reset generator circuit breaker. 2. Refer to generator manual. 3. Reset generator disconnect circuit breaker in transfer switch.
Automatic transfer switch does not transfer to utility	<ol style="list-style-type: none"> 1. Utility disconnect circuit breakers open in transfer switch. 2. Utility voltage not acceptable. 	<ol style="list-style-type: none"> 1. Reset utility disconnect circuit breaker in transfer switch. 2. Wait for utility voltage to return to normal.
Generator is still running after switch transfers to utility power	Engine cool down period.	Engine should stop after 1 minute.
Generator or supervised loads (air conditioner, etc.) are operating improperly when generator is supplying power	<ol style="list-style-type: none"> 1. AA and/or BB are not operating correctly. 2. Too much load on generator. 3. Current transformer not connected. 4. Broken current transformer. 	<ol style="list-style-type: none"> 1. Five minute delay timer has not expired. 2. Decrease load to generator. 3. Contact local authorized service center. 4. Contact local authorized service center.
Generator is still running after utility power is restored	<ol style="list-style-type: none"> 1. Minimum engine run time has not elapsed. 2. Fuse(s) in transfer switch is defective. 	<ol style="list-style-type: none"> 1. Wait five minutes for transfer switch to retransfer to utility power. 2. Contact local authorized service center.

Automatic Transfer Switch

Product Specifications

Model 071058

Rated Maximum Load Current Per Contactor at 77°F (25°C)*	200 Amps
Rated AC Voltage	250 Volts
Poles Per Contactor	2
Frequency	60 Hz
Fault Current Rating	25,000 RMS Symmetrical Amperes
Normal Operating Range	-20°F (-28.8°C) to 104°F (40°C)
Weight	110 lbs (50 kg)
Dimensions (HxWxD)	37in. x 24in. x 7in. (94cm x 61cm x 18cm)

This transfer switch is a UL Listed device.